

cisal

*CUBIC
Collection*

design by Cisol Atelier



cisal



cisal

PAITARDON

«La bellezza del luogo ci illude, e a momenti ci fa credere che il tempo si sia fermato»

Orta mia. Mario Soldati 1960

“The beauty of this place deceives us, and at times makes us believe that time stands still”

Orta mia. Mario Soldati 1960



CHI SIAMO

CISAL rappresenta un esempio di industria italiana autonoma ed integrata, a ciclo di produzione completo, caratterizzato da soluzioni tecnologiche e gestionali innovative. Cisol è oggi uno dei protagonisti dell'innovazione nel settore, con grande sensibilità per l'efficiente uso delle risorse, in primis acqua ed energia, e costante attenzione allo sviluppo continuo di prodotti innovativi nel design, nei materiali, nel funzionamento e nelle prestazioni. Le Collezioni combinano sapientemente estetica, funzionalità e affidabilità, grazie alla collaborazione con designers internazionali quali Karim Rashid, Giampiero Peia, Fabio Rotella, the Collections masterfully combine aesthetics, functionality and reliability.

ABOUT US

Cisal is the outstanding example of an independent and fully integrated Italian manufacturer, performing the complete production cycle, characterised by innovative technology and management solutions.

Cisal is now one of the leading innovators in the industry and is very conscience about the efficient use of resources, water and energy, and focuses on the continuous development of innovative products with regard to design, materials, function and performance. Thanks to collaboration with international designers such as Karim Rashid, Giampiero Peia, Fabio Rotella, the Collections masterfully combine aesthetics, functionality and reliability.



1952

Fondata nel 1952 da Liborio Soldi e battezzata CISAL, la società ha attraversato tutte le stagioni dell'epopea della rubinetteria di cui il Cusio è protagonista fin dagli albori.

Founded in 1952 by Liborio Soldi and named CISAL, the company has gone through all the epic seasons of brassware industry where Cusio has been the protagonist since the beginning.



1980

Nel 1980 l'Arch. Raffaella Vecchi disegna la serie ARCANA, un prodotto icona classico e storico che apre nuovi orizzonti nei mercati esteri, che si sviluppano passando anche attraverso la creazione di una filiale in Germania nel 1991.

In 1980 the Architect Raffaella Vecchi, designed the ARCANA series, a classical and historical icon that opens up new horizons in foreign markets, which also led to the establishment of a daughter company in Germany in 1991.



1981

Dal lavoro di sviluppo interno coordinato da Daniele Sirini, nasce la prima cartuccia a dischi ceramici monocomando. Il nuovo BLITZ apre la gloriosa storia delle serie di miscelazione Cisol.

The first single handle ceramic disc cartridge was developed internally by Daniele Sirini and his team. The glorious history of Cisol mixer series begins with the new BLITZ series.



1999

Nel 1999, viene realizzato un nuovo stabilimento disegnato dall'Arch. Giampiero Peia e attrezzato con modernissimi impianti di cogenerazione, galvanica e magazzino elettronico. Qui si concentrano le tecnologie più avanzate del settore e si supporta una crescita continua nella progettazione del prodotto, nell'ingegnerizzazione del manufatto e del prodotto finito.

In 1999, a new factory building designed by the architect Giampiero Peia was built and equipped with modern cogeneration and plating plants along with an electronic warehouse. Here, using the most advanced technologies in the industry, product design and the engineering of the part and the finished product are in continuous development.



2009

Nel 2009 la famiglia Huber, proprietaria di Huber, leader nella fabbricazione di miscelatori termostatici, decide di fare una scelta strategica per il futuro, acquisendo Cisol per garantirle un asse di sviluppo tecnologico e industriale assolutamente vincente: combinare know-how, esperienza e capacità produttive per offrire al progettista e alla clientela una variegata e completa gamma di prodotti integrati a miscelazione termostatica, monocomando e tradizionale.

In 2009 the Huber family, owner of Huber, a leading manufacturer of thermostatic mixers, decided to make a strategic choice for the future, by acquiring Cisol and providing the company with an absolutely successful technological and industrial development format: to combine know-how, experience and production capacities in order to offer designers and customers a wide and complete range of single lever, traditional, and thermostatic brassware products.



2016

Nel 2016 l'Architetto Fabio Rotella entra a far parte del team dell'azienda e in qualità di art director ha ideato "CISALAtelier", centro creativo che, attraverso la ricerca e la sperimentazione, lavora su progetti di prodotti sempre più protagonisti, grazie ad un autentico appeal.

Architect Fabio Rotella joining the team in 2016 as the brand art director, he developed the "CISALAtelier" concept, a creative network which, through research and experimentation, will be protagonist on projects of key products thanks to their authentic appeal.



ECCELLENZA MADE IN ITALY

Cisal rappresenta un capitolo importante della storia della rubinetteria italiana. Una lunga tradizione di ingegno, mestiere e professionalità, declinata ed esaltata nel rispetto e nella considerazione per l'uomo ed il territorio: il Lago d'Orta, luogo in cui si concentra da generazioni il distretto della rubinetteria, retaggio di artigianalità e cultura del saper fare italiano.

MADE IN ITALY EXCELLENCE

Cisal represents an important chapter in the history of Italian brassware. A long tradition of ingenuity, skill and professionalism, identified and enhanced in respect and consideration for humans and the territory: Lake Orta, the area where taps have been made for generations, has a heritage of craftsmanship and a culture of Italian know-how.



cisal *Atelier* CONCEPT

L'acqua è l'elemento essenziale per l'essere umano e il suo controllo è importante sin dall'antichità. Il rubinetto, dispensatore del liquido vitale del quale facciamo un utilizzo quotidiano, è un prodotto funzionale e necessario ma può anche rappresentare un accessorio sofisticato, prezioso e sempre più protagonista nell'ambiente bagno. Cisol storicamente ha da sempre caratterizzato la sua vasta gamma di collezioni con un atteggiamento di ricerca formale riferito al design. Più recentemente, con l'integrazione delle competenze della famiglia Huber, Cisol si è ulteriormente elevata ad ancora più alti livelli di qualità e prestigio, affermandosi come un importante interprete del settore bagno e cucina a livello internazionale.

Nel 2016 l'Architetto Fabio Rotella entra a far parte del team dell'azienda e in qualità di art director ha ideato "CISALAtelier", centro creativo che, attraverso la ricerca e la sperimentazione, lavora su progetti di prodotti sempre più protagonisti, grazie ad un autentico appeal.

"In questi anni di grandi cambiamenti, in un contesto internazionale sempre più sofisticato e in continua evoluzione, Cisol, nella sua nuova visione strategica, intende sviluppare ed elevare la propria immagine rendendola unica e riconoscibile, e aumentare la percezione dei suoi prodotti e delle sue innovazioni sullo scenario globale. Nuovi materiali, nuove finiture, nuovi dettagli e nuove tecnologie per controllare e preservare l'acqua. Cisol si presenta come un'azienda Italiana di tradizione e all'avanguardia, proiettata verso il futuro e sempre più attenta alle attese di designers e utilizzatori e alla salvaguardia dell'elemento essenziale per il Pianeta: l'acqua."

Fabio Rotella

Water is the essential element for the human being - and controlling it has been important since ancient times.

The tap, dispenser of this vital liquid of which we use daily, is a functional and necessary product, but it can also be a sophisticated, precious accessory as well that plays an increasingly important role in the bathroom environment. Since its origin, Cisol's wide range of collections have always been characterized by formal research related to design. Recently, with the integration of the expertise of the Huber family, Cisol has elevated its already high levels of quality and prestige even further, establishing itself internationally as a major interpreter of the bathroom and kitchen industry.

Architect Fabio Rotella joining the team in 2016 as the brand art director, he developed the "CISALAtelier" concept, a creative network which, through research and experimentation, will be used on projects of key products thanks to their authentic appeal.

"During these years of great change, in an international context that is becoming more sophisticated and is constantly evolving, Cisol, with its new strategic vision, aims to develop and enhance its image, making it unique and recognizable, and to globally increase the perception of its products and innovations. New materials, new finishes, new details and new technologies to control and preserve water. Cisol is a cutting-edge, future-oriented Italian company that is rich in tradition and is increasingly aware of the expectations of designers and users, and the preservation of the essential element of our planet: water."

Fabio Rotella



WATER CREATIVITY

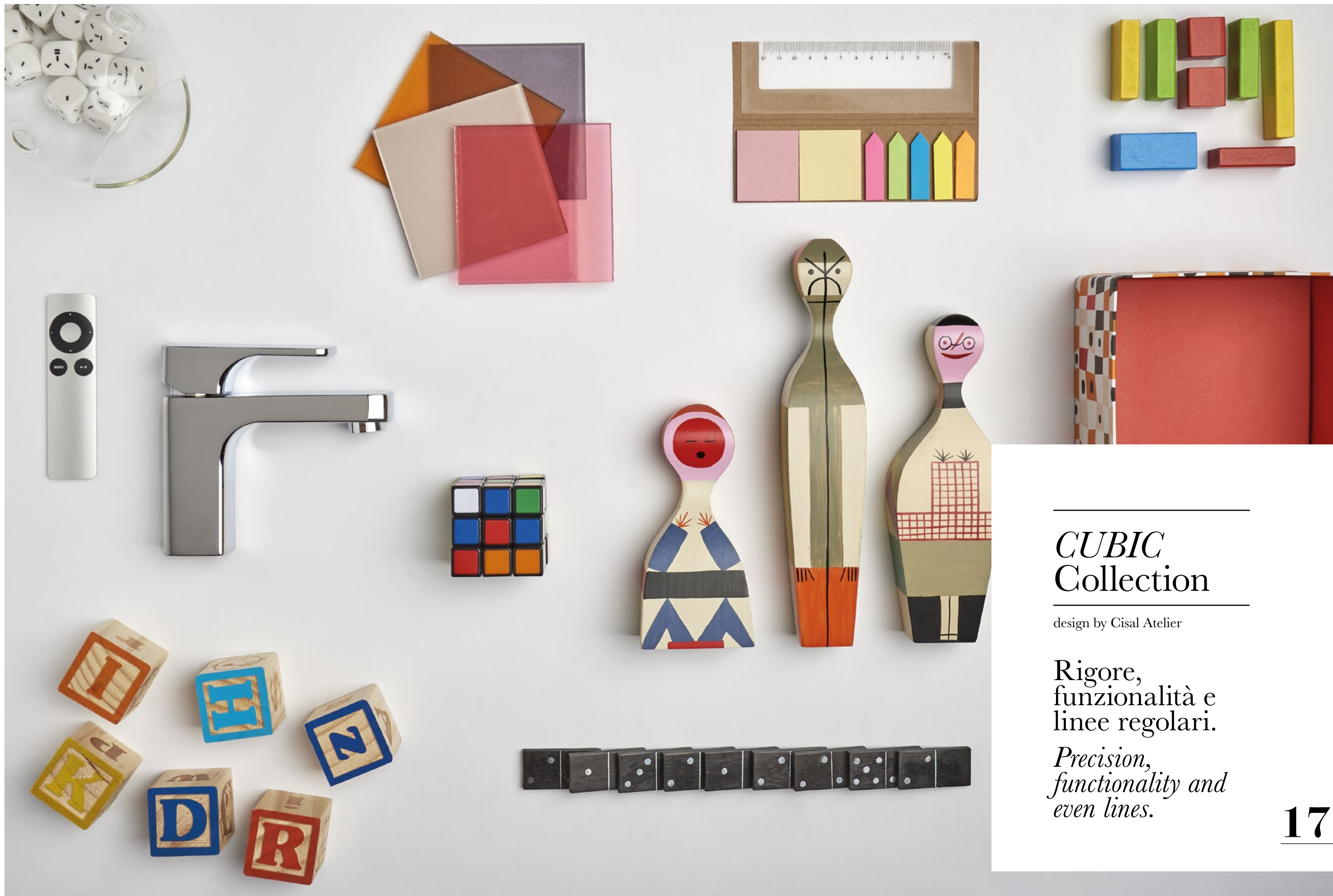

CUBIC Collection

design by Cital Atelier

Rigore,
funzionalità e
linee regolari.

*Precision,
functionality and
even lines.*

CUBIC



18

CU 51
Monocomando Lavabo
Basin Mixer



19



20



CU C49
Monocomando Lavabo Cascata
Waterfall Basin Mixer

21

CUBIC

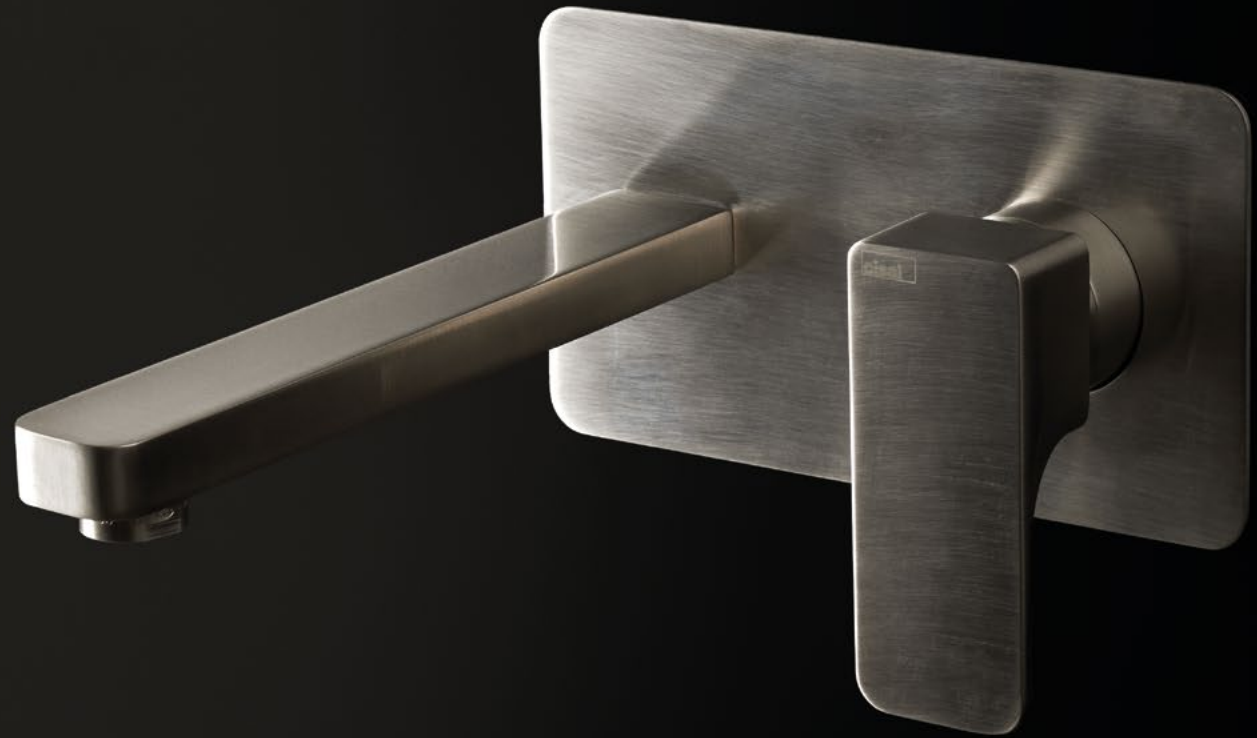

22

CU 551
Monocomando Lavabo
Basin Mixer



23

CUBIC



CU 55
Monocomando Bidet
Bidet Mixer

24



CU 47
Monocomando Lavabo
Basin Mixer



CU 354
Monocomando Lavabo
Basin Mixer

25



CU 102
Batteria Lavabo
Basin Set



CU 1351
Batteria Lavabo
Basin Set

CUBIC



28

CU D2102
Completo Termostatico Vasca
Thermo Bath/S. Set



29

CUBIC



CU 210
Monocomando 2 Uscite
2-Outlet Mixer



CU 300
Monocomando Doccia
Shower Mixer

30



DS 1004
Completo Doccia Saliscendi
Slide Rail Shower Set



DS 1357
Soffione 2 Funzioni
2-Function Shower Head

CU 1820
Termostatico 3 Uscite
3-Outlet Thermo

DS 1880
Completo Doccia con Presa d'Acqua
Shower Set on Wall Elbow

31



32



33

CUBIC



34

CU C7808
CombiDoccia Termostatico
Thermo CombiShower



35

CU C7807
CombiDoccia Termostatico
Thermo CombiShower

CUBIC



36

CU C8601
CombiDoccia Termostatico
Thermo CombiShower



37

CUBIC



38



CU 720
Termostatico 3/4"
3/4" Thermo



CU 331
Rubinetto
Stopvalve



CU 1R30
Termostatico 3 Funzioni
3-Function Thermo

39

CUBIC



40

CU IV30
Termostatico 3 Funzioni
3-Function Thermo



41



QU 9021
Porta Salviette
Towel Rail



QU 9062
Dispenser Sapone
Soap Dispenser

CUBIC



QU 09091
Porta Salviette
Free-Standing Towel Rail

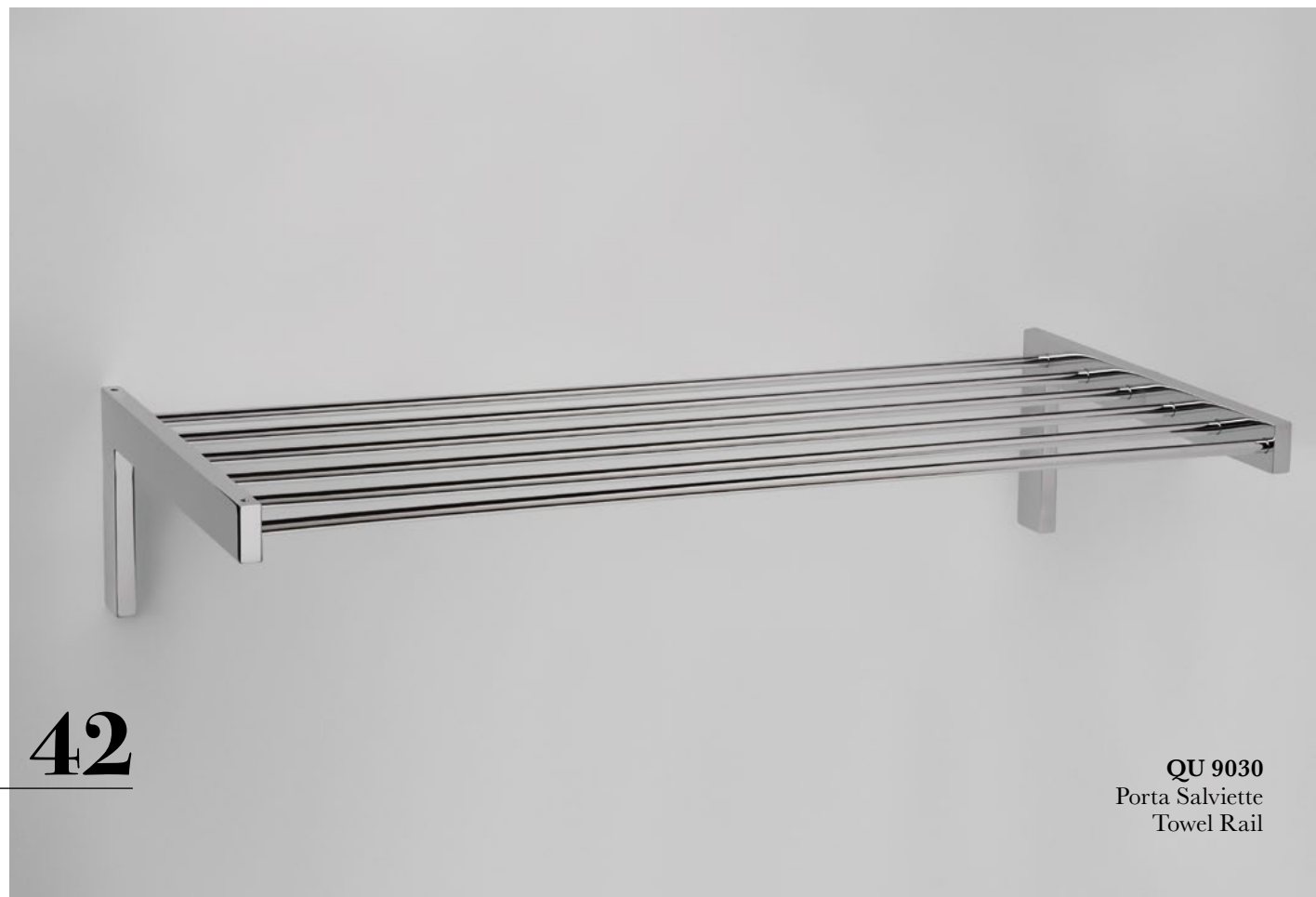

QU 9030
Porta Salviette
Towel Rail



Prodotti e Accessori
Products and Accessories
Produits et Accessoires

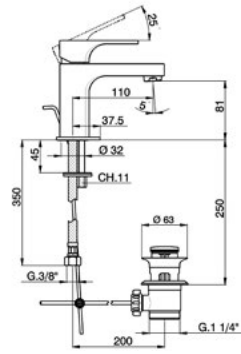

CU 000511
 Monocomando Lavabo
 Basin Mixer
 Mitigeur Lavabo

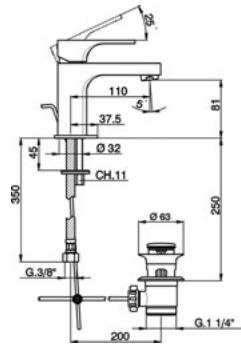

CU 000515
 Monocomando Lavabo
 Basin Mixer
 Mitigeur Lavabo
 EnergySave

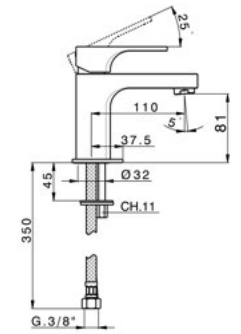

CU 000541
 Monocomando Lavabo
 Basin Mixer
 Mitigeur Lavabo

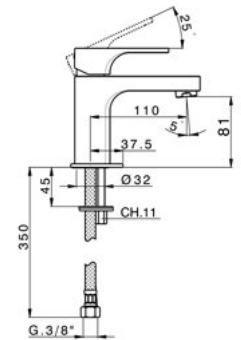

CU 000545
 Monocomando Lavabo
 Basin Mixer
 Mitigeur Lavabo
 EnergySave

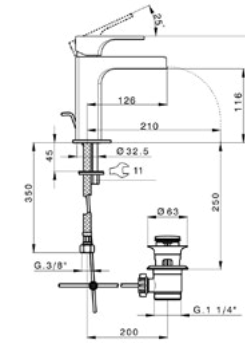

CU 00C494
 Monocomando Lavabo
 Basin Mixer
 Mitigeur Lavabo

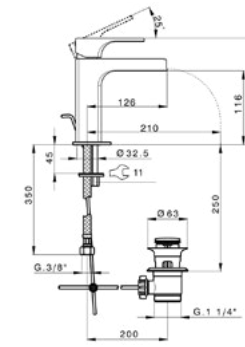

CU 00C495
 Monocomando Lavabo
 Basin Mixer
 Mitigeur Lavabo
 EnergySave

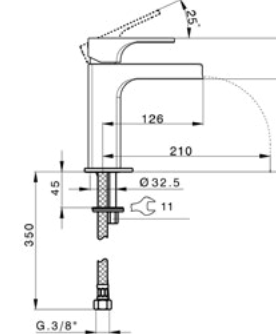

CU 00C504
 Monocomando Lavabo
 Basin Mixer
 Mitigeur Lavabo

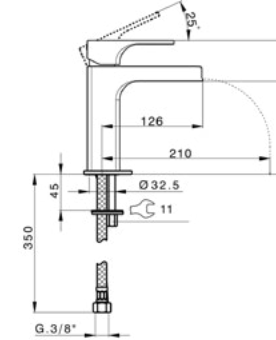

CU 00C505
 Monocomando Lavabo
 Basin Mixer
 Mitigeur Lavabo
 EnergySave

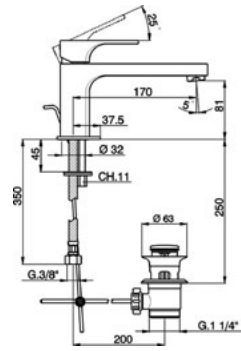

CU 001511
 Monocomando Lavabo
 Basin Mixer
 Mitigeur Lavabo

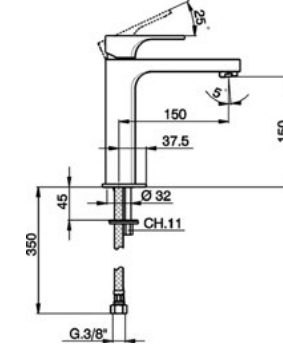

CU 001501
 Monocomando Lavabo
 Basin Mixer
 Mitigeur Lavabo

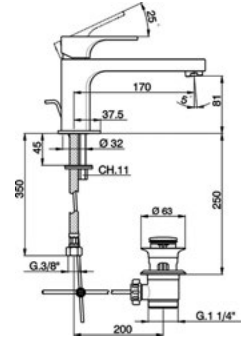

CU 001515
 Monocomando Lavabo
 Basin Mixer
 Mitigeur Lavabo

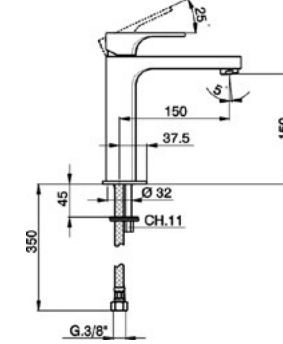
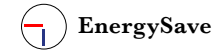

CU 001505
 Monocomando Lavabo
 Basin Mixer
 Mitigeur Lavabo

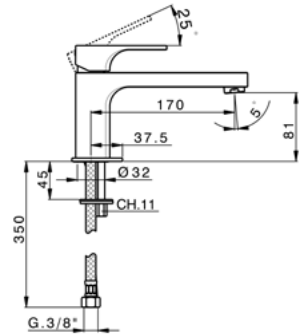
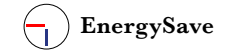

CU 001541
 Monocomando Lavabo
 Basin Mixer
 Mitigeur Lavabo

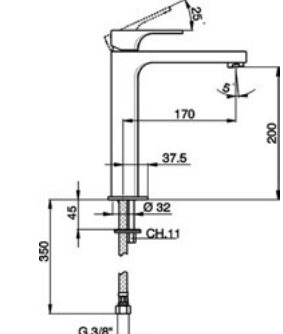

CU 003541
 Monocomando Lavabo
 Basin Mixer
 Mitigeur Lavabo

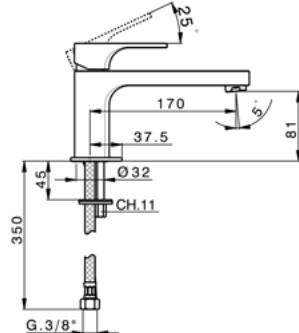

CU 001545
 Monocomando Lavabo
 Basin Mixer
 Mitigeur Lavabo

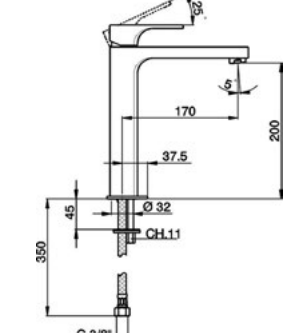
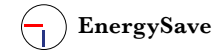

CU 003545
 Monocomando Lavabo
 Basin Mixer
 Mitigeur Lavabo



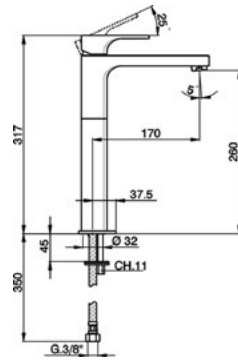

CU 004541
 Monocomando Lavabo
 Basin Mixer
 Mitigeur Lavabo

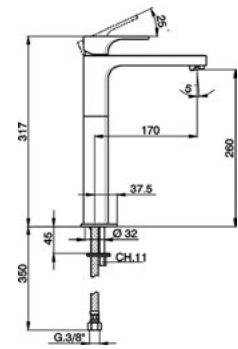

CU 004545
 Monocomando Lavabo
 Basin Mixer
 Mitigeur Lavabo

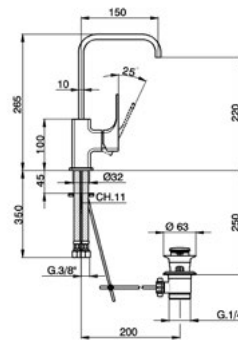
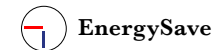

CU 000475
 Monocomando Lavabo
 Basin Mixer
 Mitigeur Lavabo

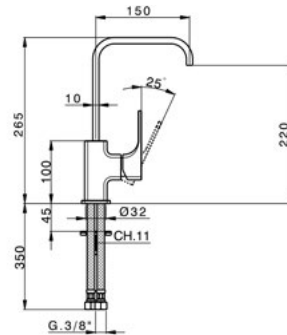
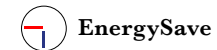

CU 000485
 Monocomando Lavabo
 Basin Mixer
 Mitigeur Lavabo

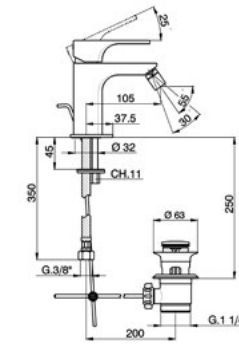
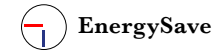

CU 000551
 Monocomando Bidet
 Bidet Mixer
 Mitigeur Bidet

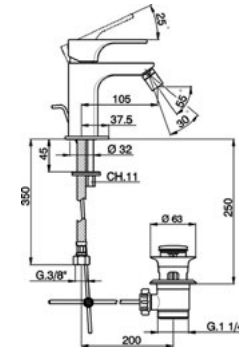

CU 000555
 Monocomando Bidet
 Bidet Mixer
 Mitigeur Bidet

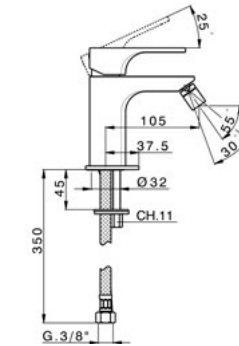
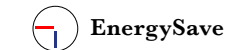

CU 000561
 Monocomando Bidet
 Bidet Mixer
 Mitigeur Bidet

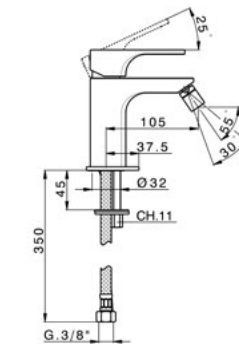

CU 000565
 Monocomando Bidet
 Bidet Mixer
 Mitigeur Bidet

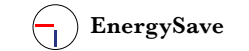



CU 001020
Batteria Lavabo
Basin Set
Lavabo 3 Trou

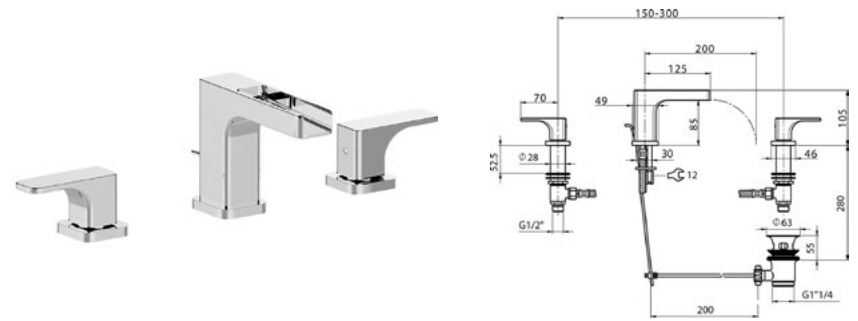

CU 0C1020
Batteria Lavabo Cascata
Waterfall Basin Set
Lavabo 3 Trou Cascade

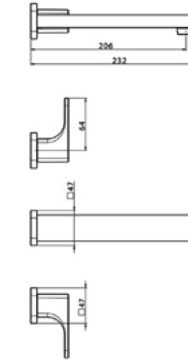
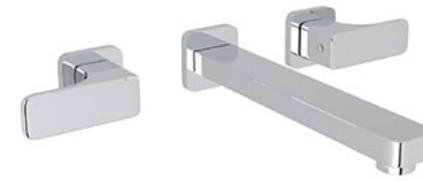

CU 013510
Parte Esterna Batteria Lavabo
Basin Set Exposed Part
Partie Apparente Lavabo Mural

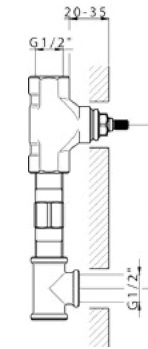

ZA 033511
Parte Incasso Batteria Lavabo
Basin Set Concealed Part
Partie Encastrée Lavabo Mural

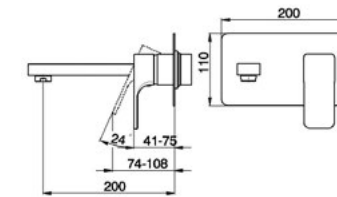

CU 005510
Parte Esterna Monocomando Lavabo
Basin Mixer Exposed Part
Partie Apparente Mitigeur Lavabo

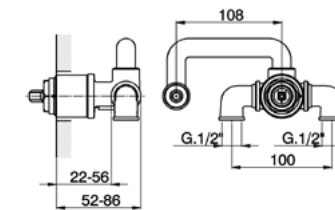

ZA 016510
Parte Incasso Monocomando Lavabo
Basin Mixer Concealed Part
Partie Encastrée Mitigeur Lavabo

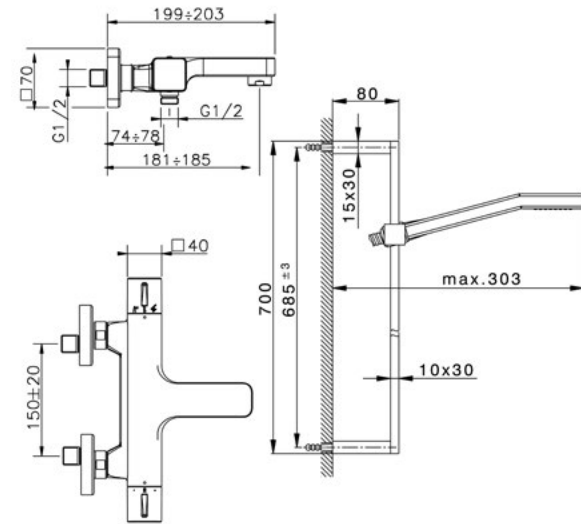

CU S21020
Completo Termostatico Vasca
Thermo Bath/S. Set
Ensemble Thermo Bain/D.

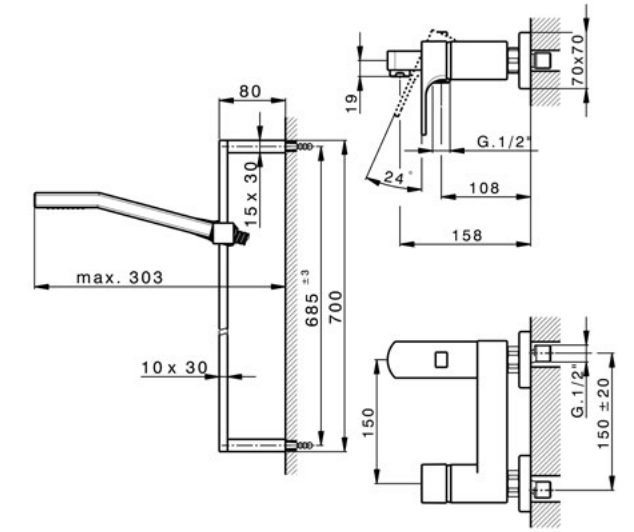

CU 00062
Completo Monocomando Vasca
Bath/S. Mixer Set
Ensemble Mitigeur Bain/D.

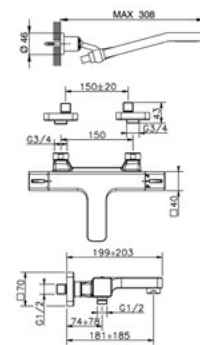

CU D21020
Completo Termostatico Vasca
Thermo Bath/S. Set
Ensemble Thermo Bain/D.

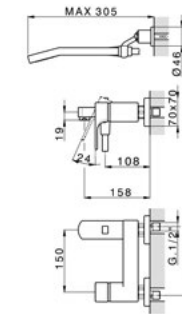

CU 000122
Completo Monocomando Vasca
Bath/S. Mixer Set
Ensemble Mitigeur Bain/D.

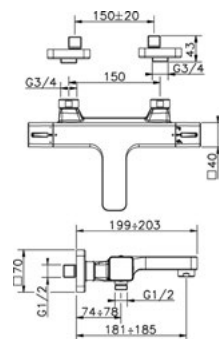

CU T21020
Termostatico Vasca
Bath/S. Thermo
Thermo Bain/D.

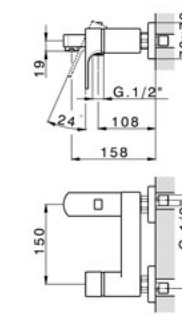

CU 000132
Monocomando Vasca
Bath/S. Mixer
Mitigeur Bain/D.

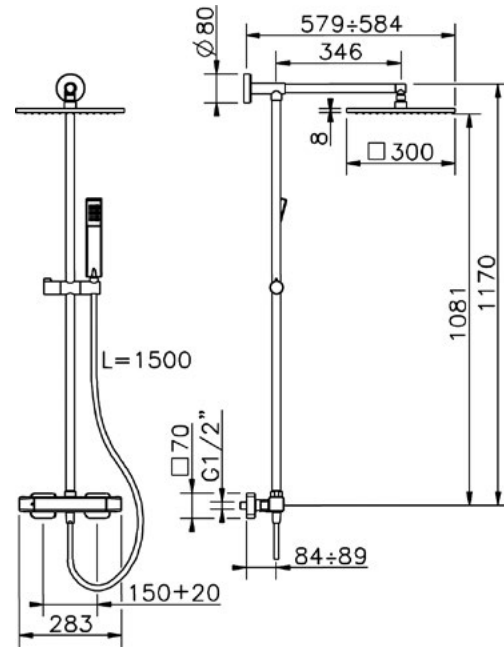

CU C78085
 CombiDoccia Termostatico
 Thermo CombiShower
 CombiDouche Thermo

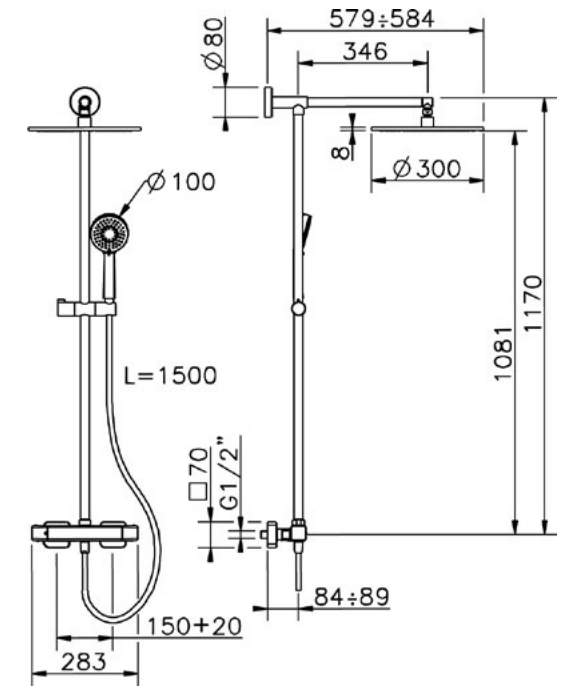

CU C78075
 CombiDoccia Termostatico
 Thermo CombiShower
 CombiDouche Thermo

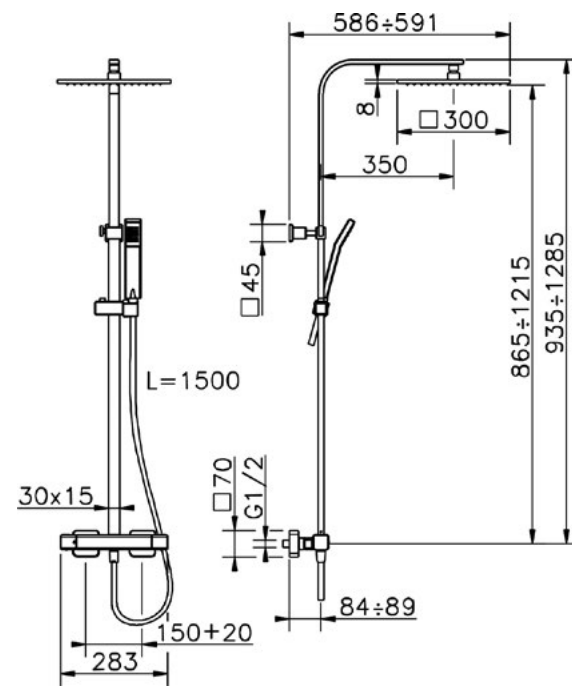

CU C8601M
 CombiDoccia Termostatico
 Thermo CombiShower
 CombiDouche Thermo

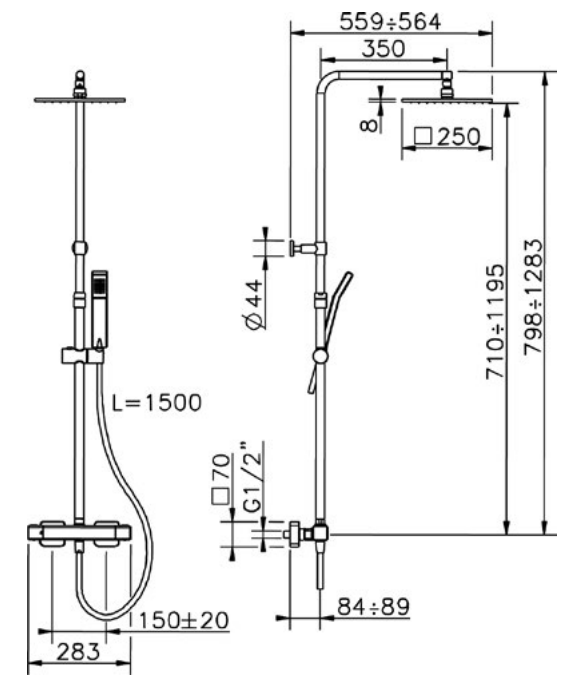

CU C8401C
 CombiDoccia Termostatico
 Thermo CombiShower
 CombiDouche Thermo

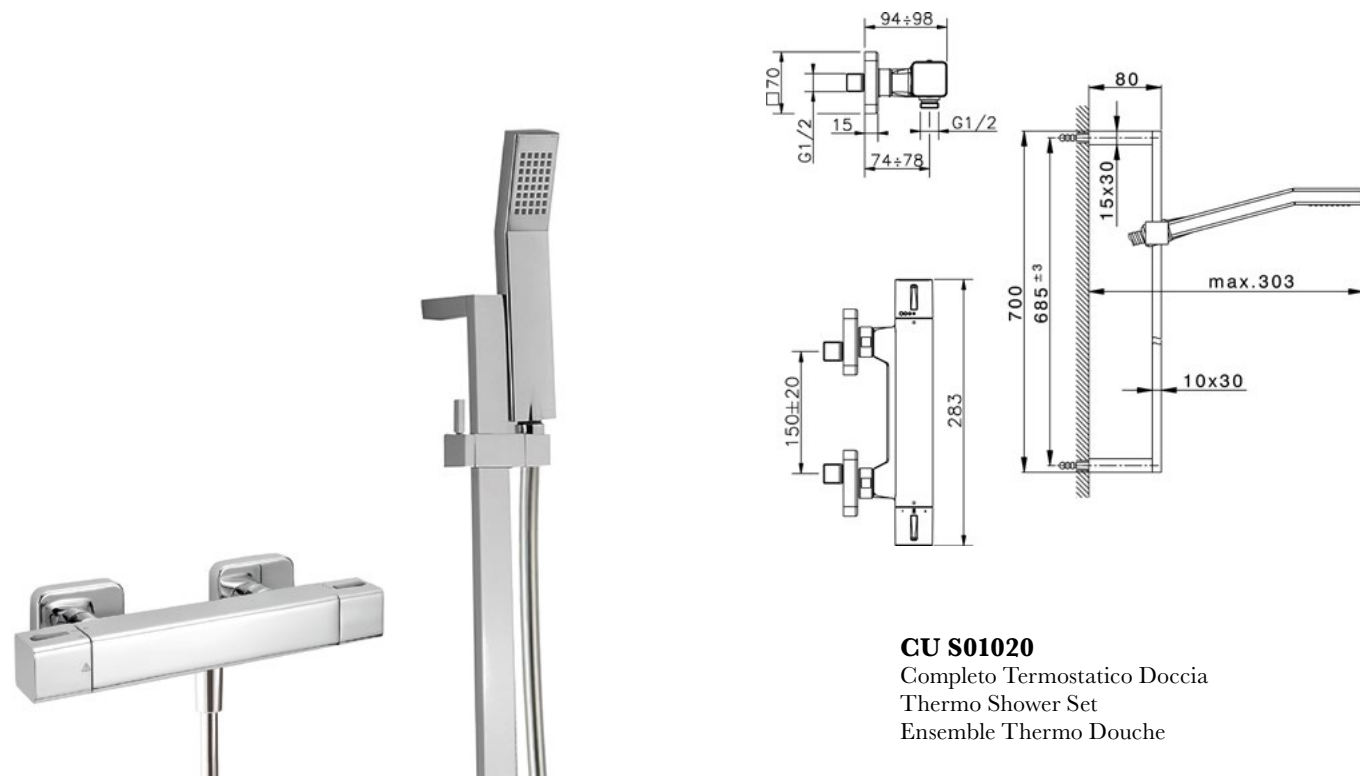

CU S01020
Completo Termostatico Doccia
Thermo Shower Set
Ensemble Thermo Douche

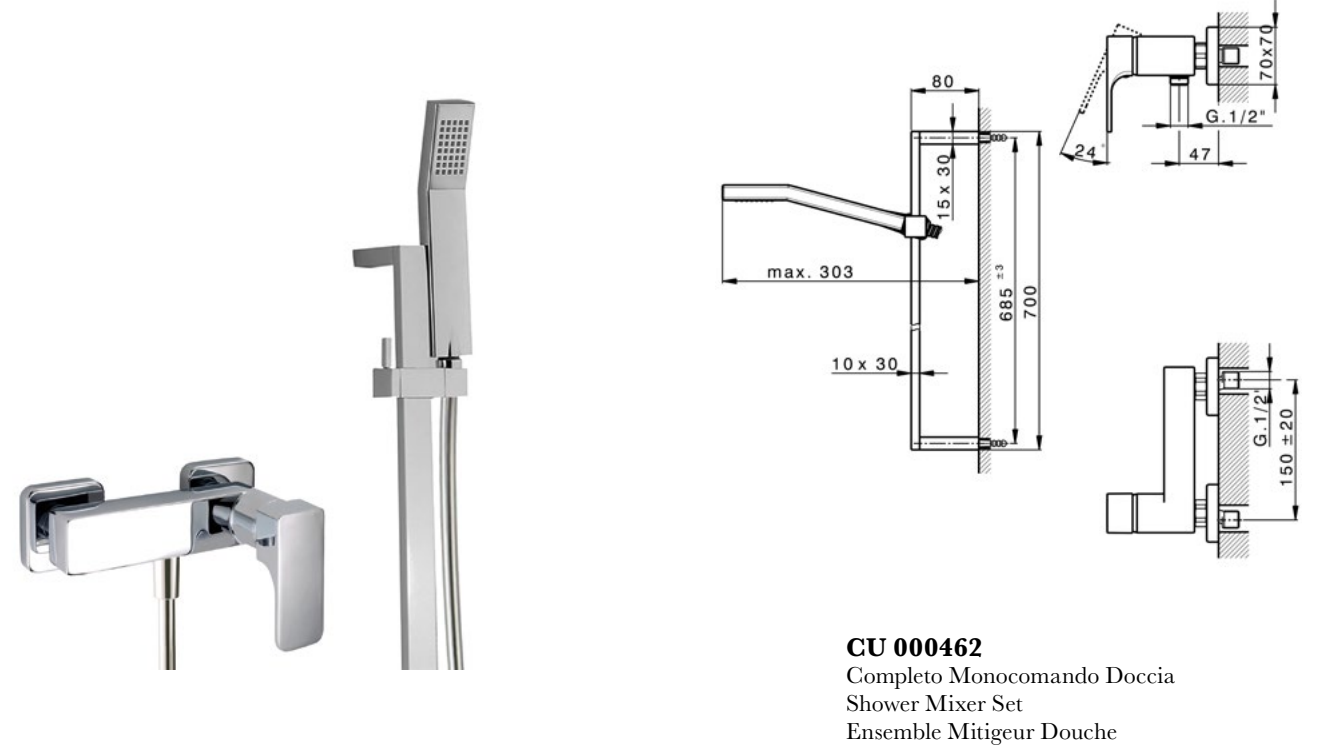

CU 000462
Completo Monocomando Doccia
Shower Mixer Set
Ensemble Mitigeur Douche

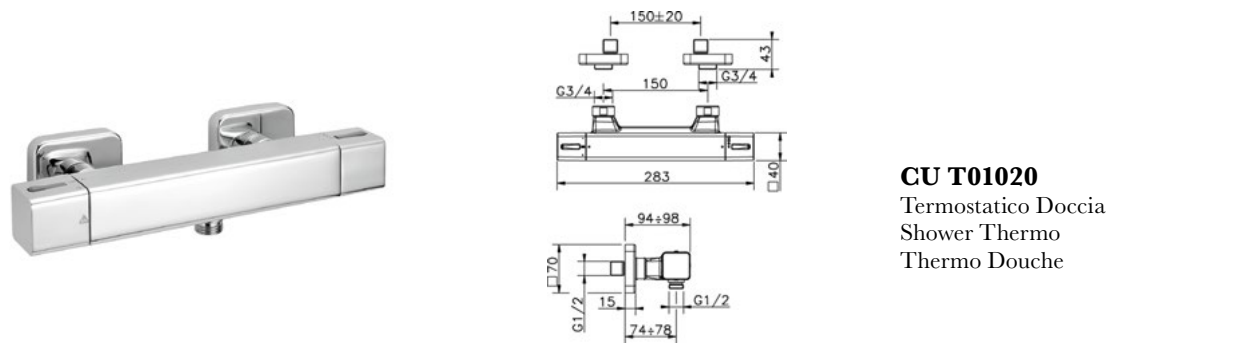

CU T01020
Termostatico Doccia
Shower Thermo
Thermo Douche

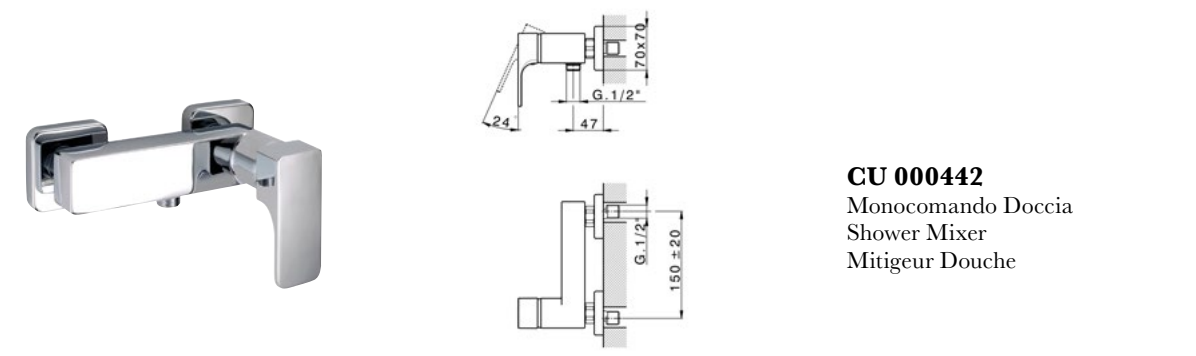

CU 000442
Monocomando Doccia
Shower Mixer
Mitigeur Douche

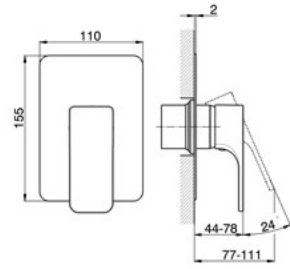

CU 003000
 Parte Esterna Monocomando Doccia
 Shower Mixer Exposed Part
 Partie Décor Mitigeur Douche

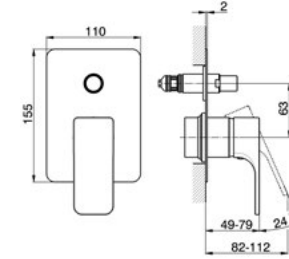

CU 002100
 Parte Esterna Monocomando 2 Uscite
 2-Outlet Mixer Exposed Part
 Partie Décor Mitigeur 2 Sorties

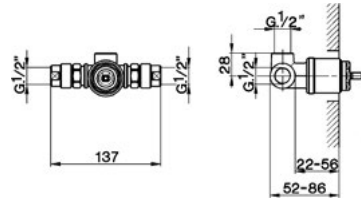

ZA 004310
 Parte Incasso Monocomando Doccia
 con Silenziatori
 Shower Mixer Concealed Part
 with Noise Reducers
 Partie Encastrée Mitigeur Douche
 avec Silencieux

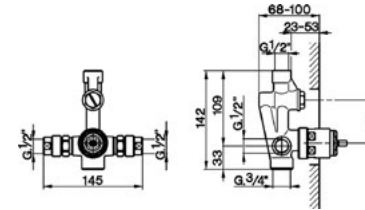

ZA 004210
 Parte Incasso Monocomando 2 Uscite
 con Silenziatori
 2-Outlet Mixer Concealed Part
 with Noise Reducers
 Partie Encastrée Mitigeur 2 Sorties
 avec Silencieux

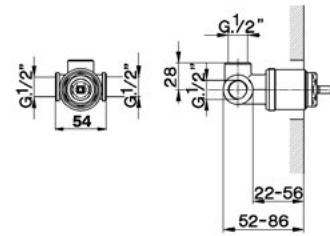

ZA 004311
 Parte Incasso Monocomando Doccia
 Shower Mixer Concealed Part
 Partie Encastrée Mitigeur Douche

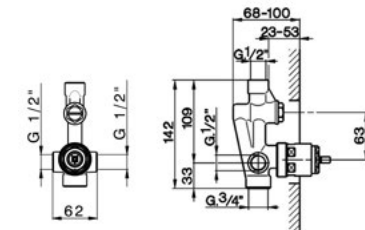

ZA 004211
 Parte Incasso Monocomando 2 Uscite
 2-Outlet Mixer Concealed Part
 Partie Encastrée Mitigeur 2 Sorties

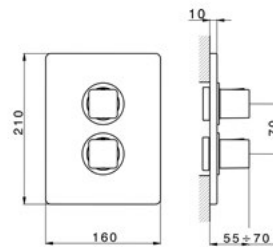

CU 007300
 Parte Esterna Termostatico Doccia
 Thermo Shower Exposed Part
 Partie Décor Thermo Douche

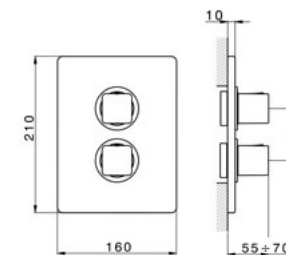

CU 018100
 Parte Esterna Termostatico 2 Uscite
 2-Outlet Thermo Exposed Part
 Partie Décor Thermo 2 Sorties

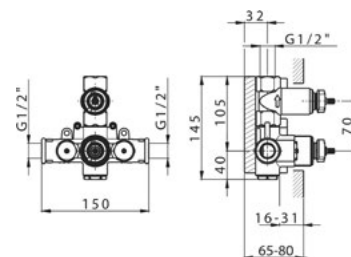

ZA 007301
 Parte Incasso Termostatico Doccia
 Thermo Shower Concealed Part
 Partie Encastrée Thermo Douche

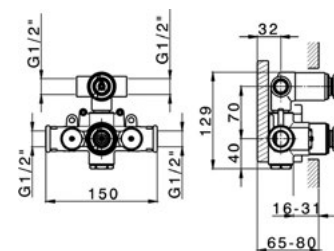

ZA 018101
 Parte Incasso Termostatico 2 Uscite
 2-Outlet Thermo Concealed Part
 Partie Encastrée Thermo 2 Sorties

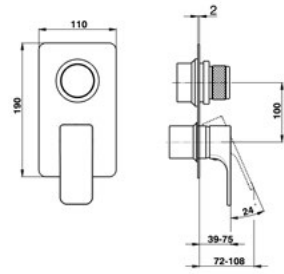

CU 002800
 Parte Esterna Monocomando 3 Uscite
 3-Outlet Mixer Exposed Part
 Partie Décor Mitigeur 3 Sorties

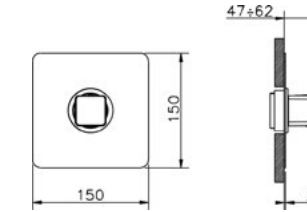

CU 007200
 Parte Esterna Termostatico 3/4\"/>

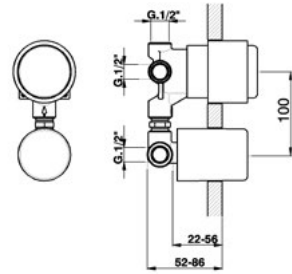

ZA 000280
 Parte Incasso Monocomando 3 Uscite
 3-Outlet Mixer Concealed Part
 Partie Encastrée Mitigeur 3 Sorties

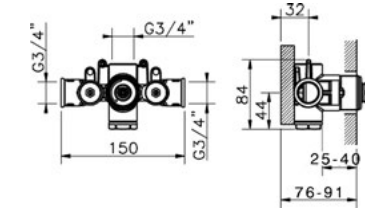

ZA 007221
 Parte Incasso Termostatico 3/4\"/>

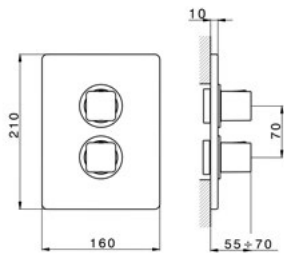

CU 018200
 Parte Esterna Termostatico 3 Uscite
 3-Outlet Thermo Exposed Part
 Partie Décor Thermo 3 Sorties

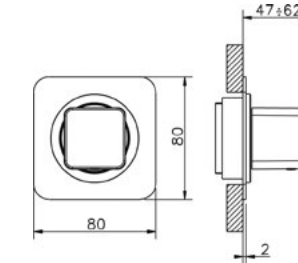

CU 003310
 Parte Esterna Rubinetto
 Stopvalve Exposed Part
 Partie Décor Robinet

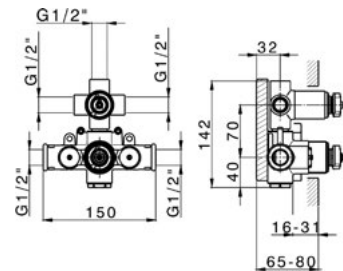

ZA 018201
 Parte Incasso Termostatico 3 Uscite
 3-Outlet Thermo Concealed Part
 Partie Encastrée Thermo 3 Sorties

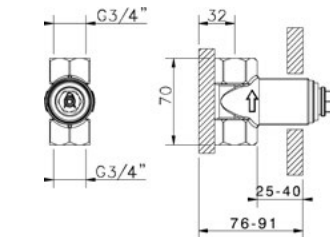

ZA 003330
 Parte Incasso Rubinetto 3/4\"/>

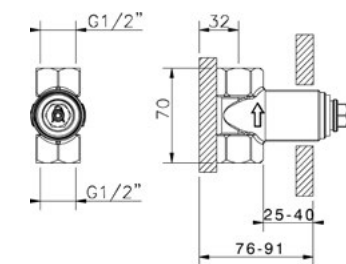

ZA 003340
 Parte Incasso Rubinetto 1/2\"/>

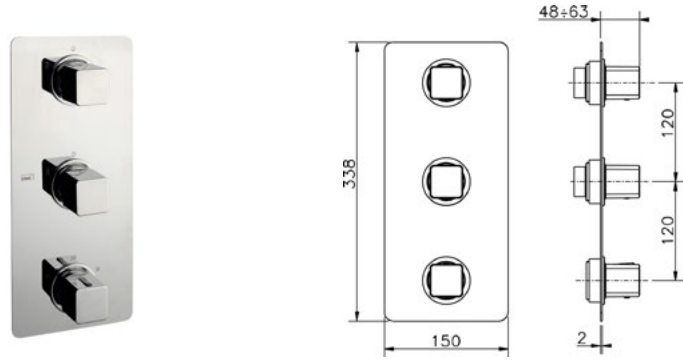

CU 01V200
 Parte Esterna Termostatico 2 Funzioni
 2-Function Thermo Exposed Part
 Partie Décor Thermo 2 Fonctions

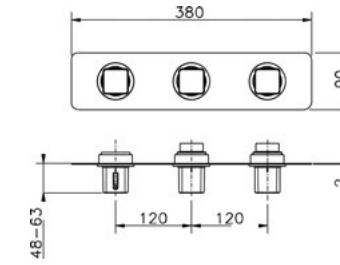

CU 01R200
 Parte Esterna Termostatico 2 Funzioni
 2-Function Thermo Exposed Part
 Partie Décor Thermo 2 Fonctions

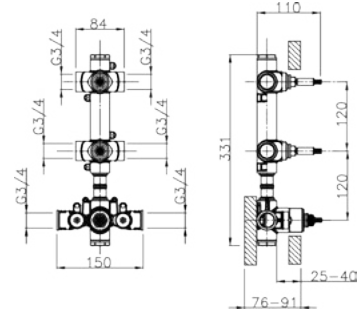

ZA 01V200
 Parte Incasso Termostatico 2 Funzioni
 2-Function Thermo Concealed Part
 Partie Encastrée Thermo 2 Fonctions

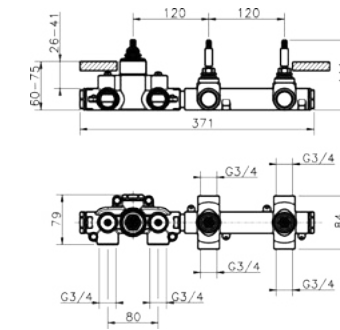

ZA 01R200
 Parte Incasso Termostatico 2 Funzioni
 2-Function Thermo Concealed Part
 Partie Encastrée Thermo 2 Fonctions

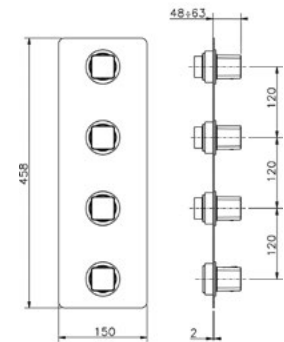

CU 01V300
 Parte Esterna Termostatico 3 Funzioni
 3-Function Thermo Exposed Part
 Partie Décor Thermo 3 Fonctions

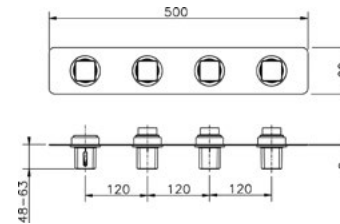

CU 01R300
 Parte Esterna Termostatico 3 Funzioni
 3-Function Thermo Exposed Part
 Partie Décor Thermo 3 Fonctions

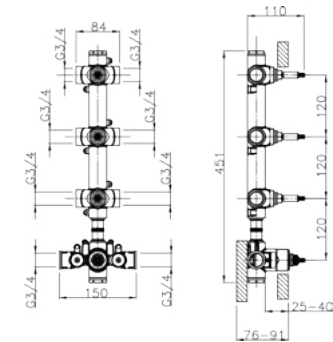

ZA 01V300
 Parte Incasso Termostatico 3 Funzioni
 3-Function Thermo Concealed Part
 Partie Encastrée Thermo 3 Fonctions

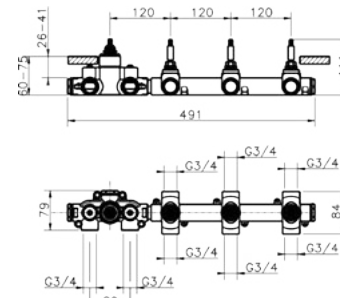

ZA 01R300
 Parte Incasso Termostatico 3 Funzioni
 3-Function Thermo Concealed Part
 Partie Encastrée Thermo 3 Fonctions

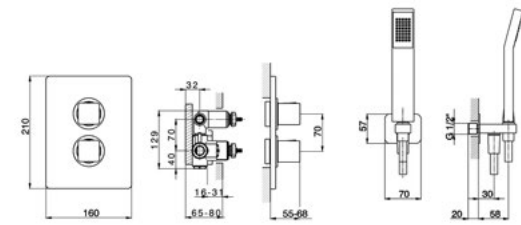
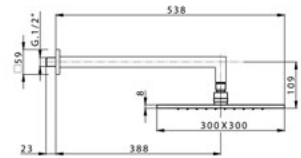

CU 0KT010
Completo Termostatico Doccia 2 Funzioni
2-Function Thermo Shower Set
Ensemble Thermo Douche 2 Fonctions

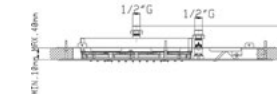
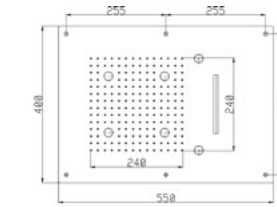

ZS 027070
Soffione Doccia a Controsoffitto Cromoterapia
4 Led RGB
3 Funzioni: Pioggia/Cascata/Nebulizzazione
Ceiling Mounted 4-Led RGB Chromotherapy
Shower Head
3 Functions: Rain/Waterfall/Nebulization
Ciel de Pluie Encastré Chromothérapie
4 Led RGB
3 Fonctions: Pluie/Cascade/Nébulisation

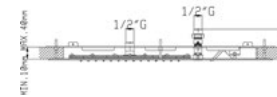
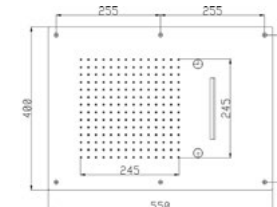

ZS 025580
Soffione Doccia a Controsoffitto
3 Funzioni: Pioggia/Cascata/Nebulizzazione
Ceiling Mounted Shower Head
3 Functions: Rain/Waterfall/Nebulization
Ciel de Pluie Encastré
3 Fonctions: Pluie/Cascade/Nébulisation

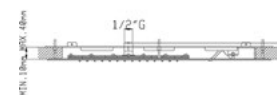
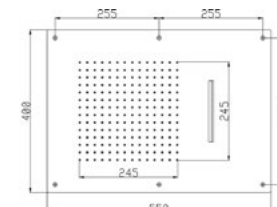

ZS 025590
Soffione Doccia a Controsoffitto
2 Funzioni: Pioggia/Cascata
Ceiling Mounted Shower Head
2 Functions: Rain/Waterfall
Ciel de Pluie Encastré
2 Fonctions: Pluie/Cascade

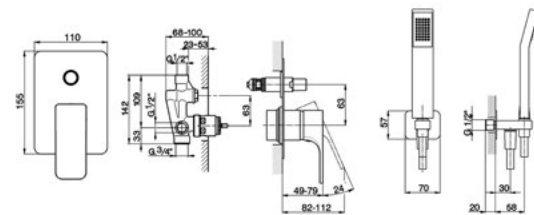
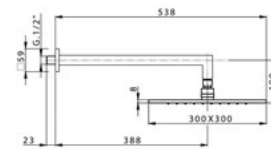

CU 0KM010
Completo Monocomando Doccia 2 Funzioni
2-Function Mixer Shower Set
Ensemble Mitigeur Douche 2 Fonctions

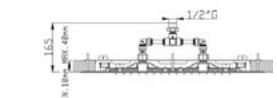
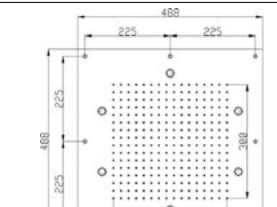

ZS 027110
Soffione Doccia a Controsoffitto Cromoterapia
6 Led RGB
Ceiling Mounted 6-Led RGB Chromotherapy
Shower Head
Ciel de Pluie Encastré Chromothérapie
6 Led RGB

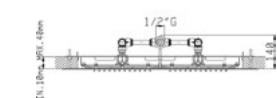
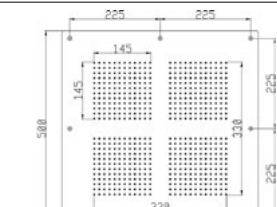

ZS 025610
Soffione Doccia a Controsoffitto
Ceiling Mounted Shower Head
Ciel de Pluie Encastré

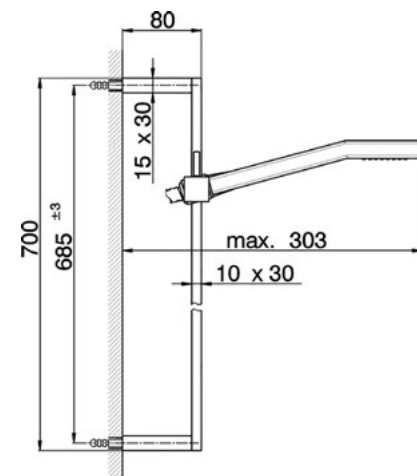

DS 010040
Completo Doccia Saliscendi
Slide Rail Shower Set
Ensemble Barre de Douche

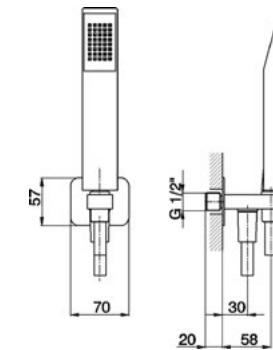

DS 018800
Completo Doccia con Presa d'Acqua
Shower Set on Wall Elbow
Ensemble de Douche sur Coude Mural

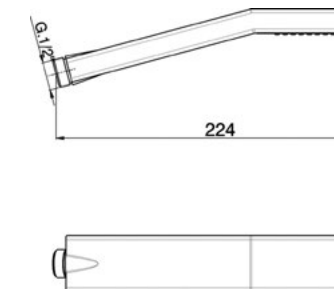

DS 014180
Doccetta
Hand Shower
Douchette à Main

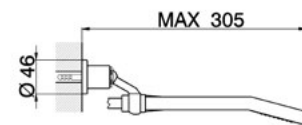

DS 018080
Completo Doccia
Shower Set
Ensemble de Douche

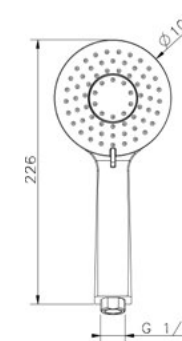

DS 014380
Doccetta 3 Funzioni
3-Function Hand Shower
Douchette à Main 3 Fonctions

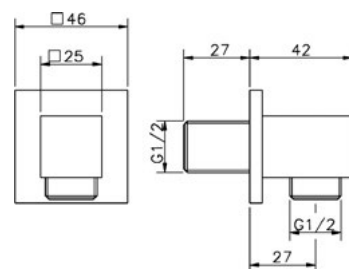

DS 017340
Presa d'Acqua
Wall Elbow
Coude Mural

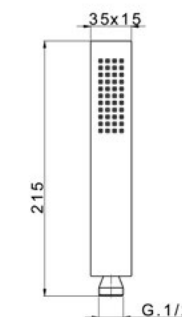

DS 014450
Doccetta Ottone
Brass Hand Shower
Douchette à Main Laiton

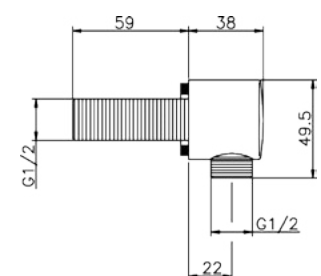

DS 017320
Presa d'Acqua
Wall Elbow
Coude Mural

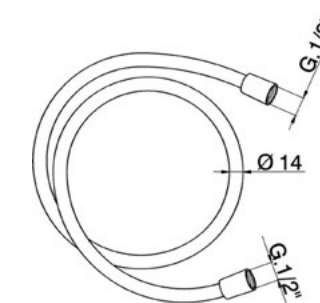

ZA 009040
Flessibile Doccia SUPREME
SUPREME Shower Hose
Flexible de Douche SUPREME

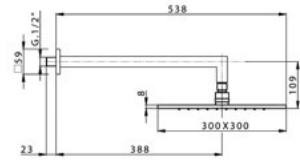

DS 013720
Braccio e Soffione Doccia
Shower Arm & Head
Bras et Tête de Douche

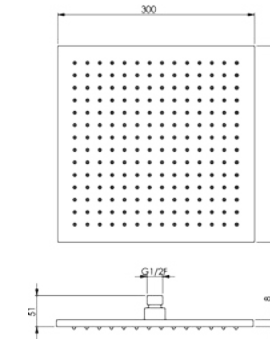

DS 016340
Soffione Doccia
Shower Head
Douche de Tête

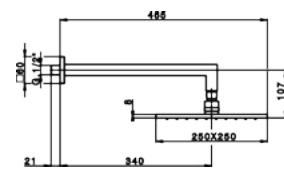

DS 013660
Braccio e Soffione Doccia
Shower Arm & Head
Bras et Tête de Douche

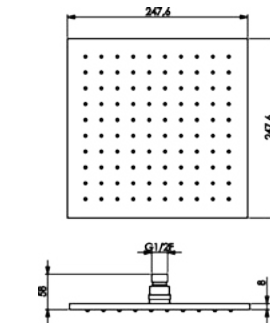

DS 016360
Soffione Doccia
Shower Head
Douche de Tête

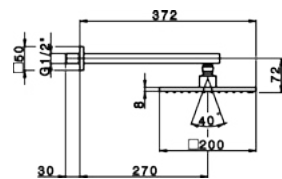

DS 013650
Braccio e Soffione Doccia
Shower Arm & Head
Bras et Tête de Douche

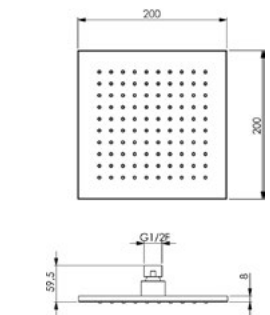

DS 016320
Soffione Doccia
Shower Head
Douche de Tête

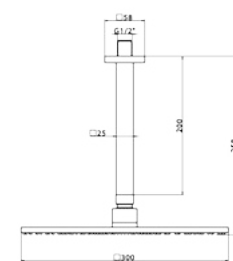

DS 013740
Braccio e Soffione Doccia
Shower Arm & Head
Bras et Tête de Douche

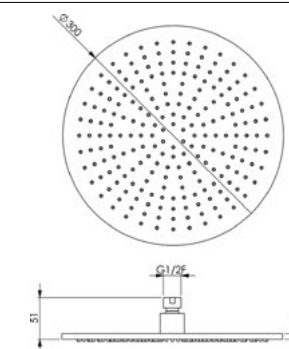

DS 016330
Soffione Doccia
Shower Head
Douche de Tête

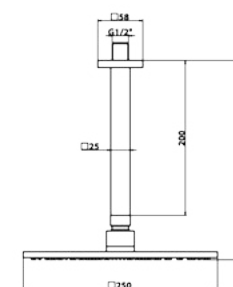

DS 013730
Braccio e Soffione Doccia
Shower Arm & Head
Bras et Tête de Douche

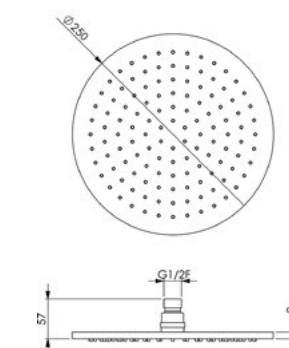
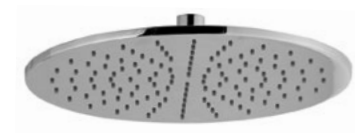

DS 016350
Soffione Doccia
Shower Head
Douche de Tête

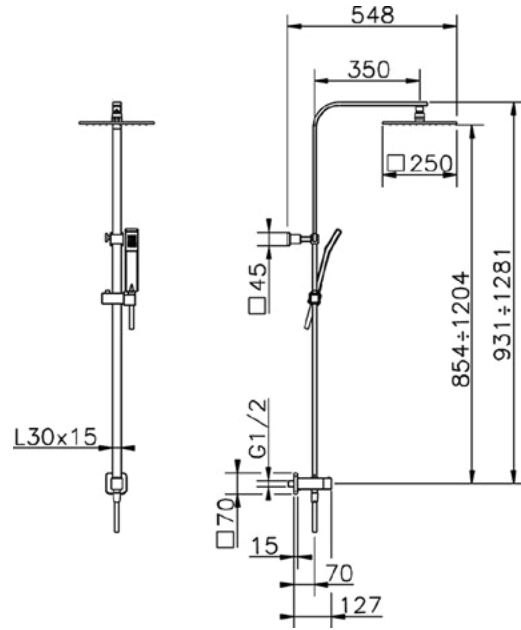

DS V86020
Completo Doccia con Presa d'Acqua
Shower Set on Wall Elbow
Ensemble de Douche sur Coude Mural

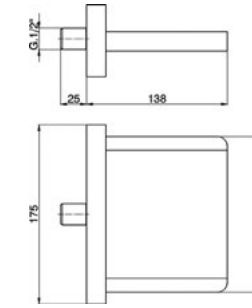
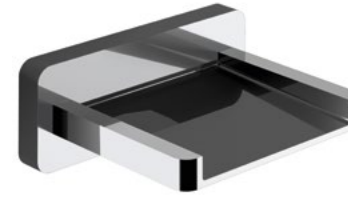

ZA 002190
Bocca a Cascata
Waterfall Spout
Bec Cascade

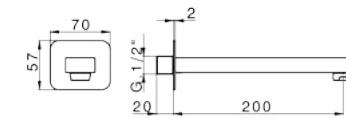

CU 000240
Bocca di Erogazione
Filler Spout
Bec Verseur

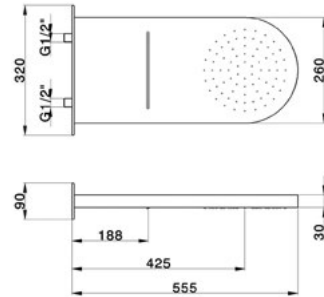

DS 013570
Soffione Doccia 2 Funzioni: Pioggia/Cascata
2-Function Shower Head: Rain/Waterfall
Douche de Tête 2 Fonctions: Pluie/Cascade

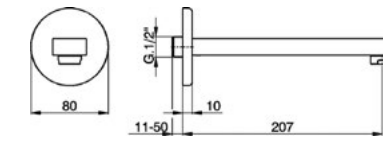
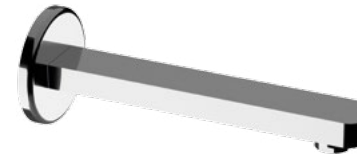

RR 000240
Bocca di Erogazione
Filler Spout
Bec Verseur

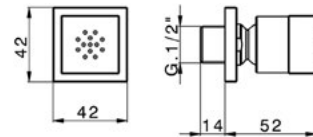

DS 015080
Soffione Laterale
Body Jet
Buse Murale

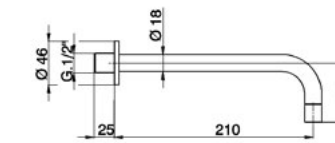

ZA 002250
Bocca di Erogazione
Filler Spout
Bec Verseur

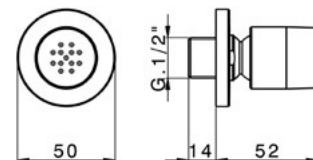

DS 015090
Soffione Laterale
Body Jet
Buse Murale

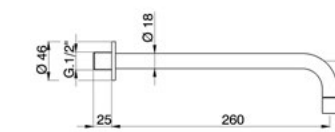

ZA 002251
Bocca di Erogazione
Filler Spout
Bec Verseur

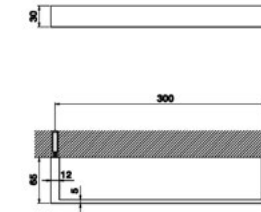

QU 090104
Porta Salviette
Towel Rail
Porte-Serviette

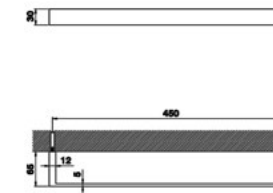

QU 090105
Porta Salviette
Towel Rail
Porte-Serviette

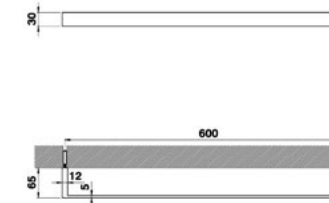

QU 090106
Porta Salviette
Towel Rail
Porte-Serviette

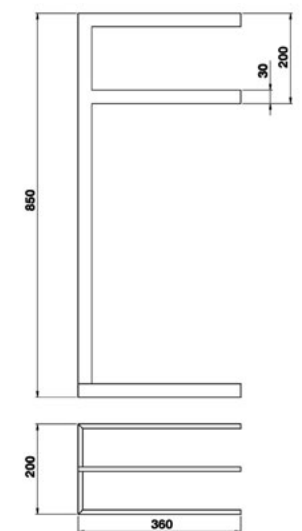

QU 090910
Porta Salviette
Free-Standing Towel Rail
Porte-Serviette

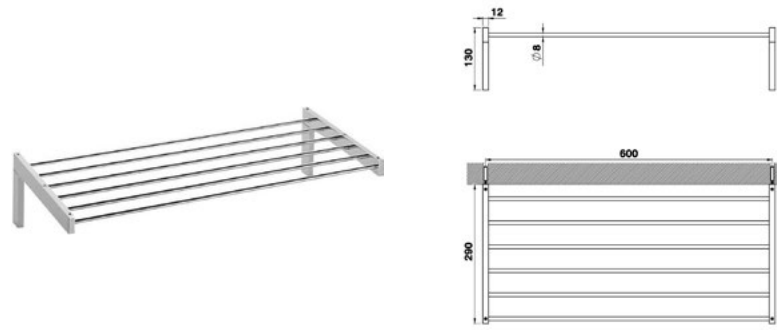

QU 090300
Porta Salviette
Towel Rail
Porte-Serviette

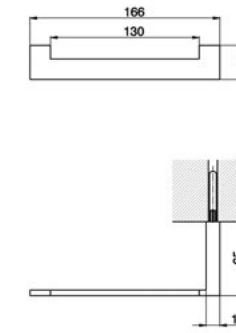

QU 090402
Porta Rotolo
Roll Holder
Porte-Papier

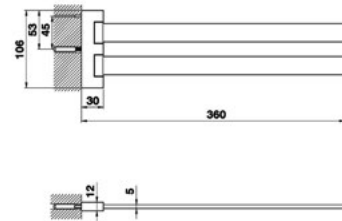

QU 090210
Porta Salviette
Towel Rail
Porte-Serviette

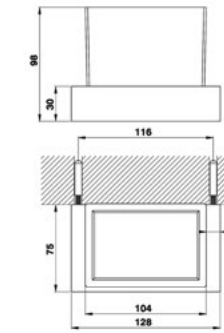

QU 090501
Porta Bicchieri
Toothbrush Holder
Porte-Verre

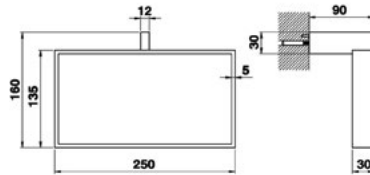

QU 090220
Porta Salviette
Towel Rail
Porte-Serviette

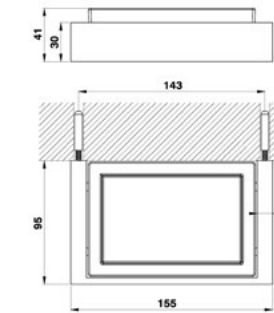

QU 090601
Porta Sapone
Soap Holder
Porte-Savon

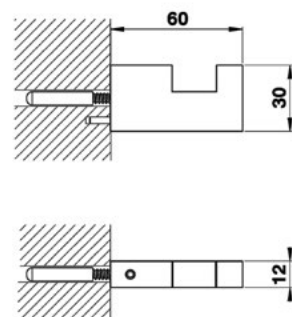

QU 090710
Appendino
Hook
Porte-Peignoir

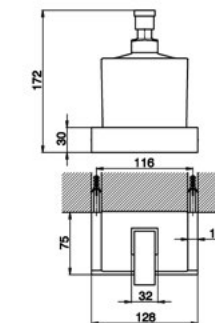

QU 090621
Dispenser Sapone
Soap Dispenser
Diffuseur de Savon

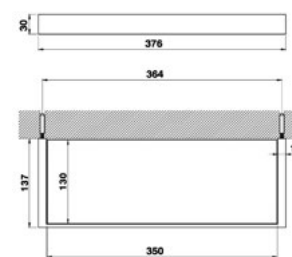

QU 090441
Mensola
Shelf
Console

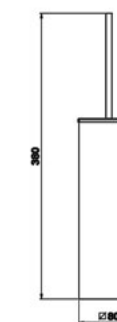

QU 090650
Porta Scopino
Brush Holder
Porte-Brosse

FINITURE | FINISHES

METALLI CLASSICI | CLASSIC METALS



Chrome
2I



Polished Nickel
2B



Brushed Nickel
2F

COLORI | COLOURS



Night Black
40

Art Direction Studio Rotella

CREDITS

Text and Editing
CISAL Atelier

Art Direction
Fabio Rotella

Graphic Design and Layout
Studio Rotella Milano

Photography
Dario De Sirianna
Marco Siracusano

Printing
Tipolitografia Testori

Thanks to
"Museo del Rubinetto e della sua Tecnologia"

Printed in Italy

cisal

cisal

cisal

Art Direction Studio Rotella



CISAL
28010 Alzo di Pella (NO) - Italia - Via Pietro Durio 160 - Tel. +39 0322 918111 - Fax +39 0322 969518
cisal@cisal.it - www.cisal.it