

XXL

lux collection by Pamesa

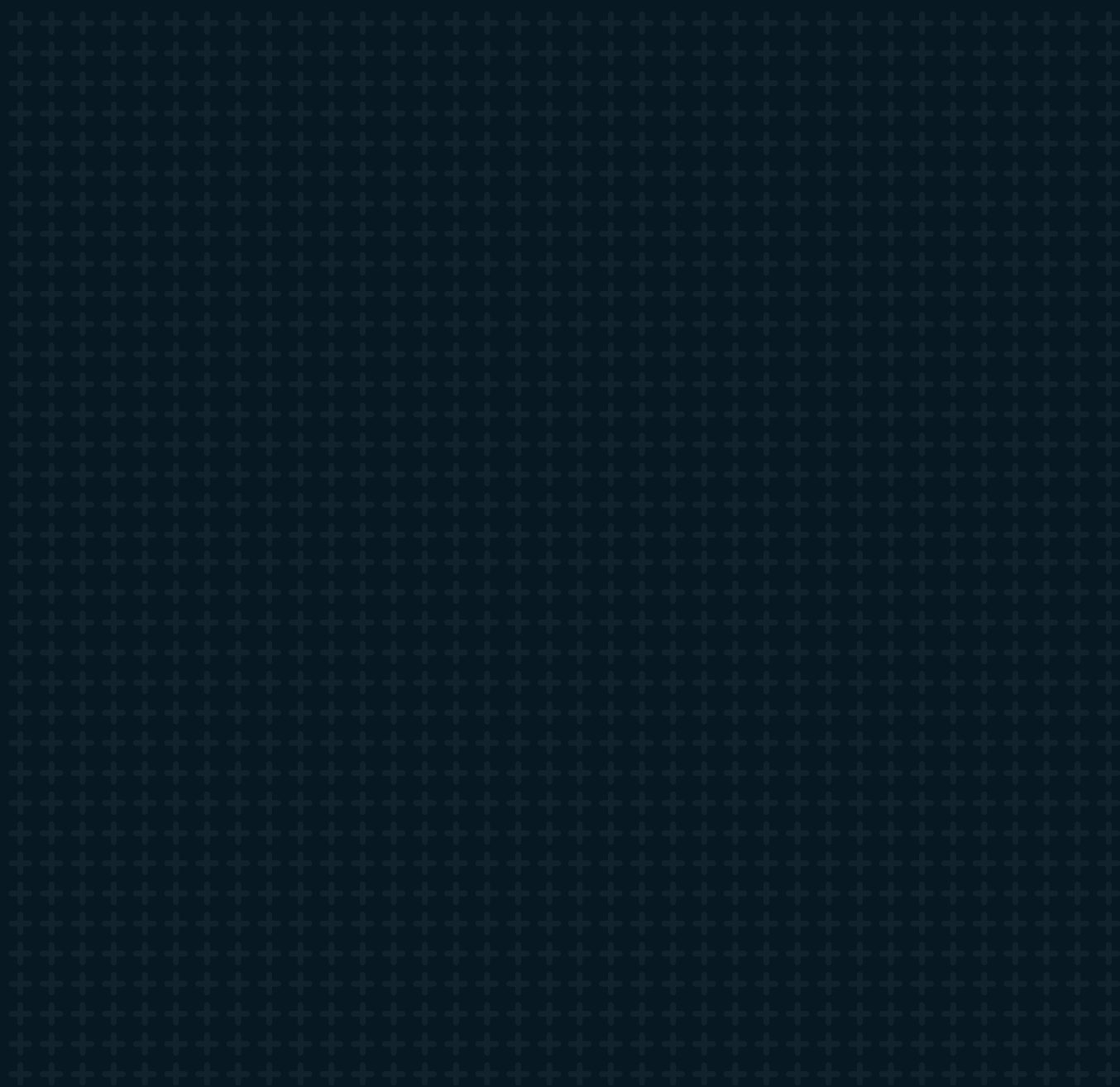

PAMESA
cerámica

Índice

Index / Index

07
CELLINI

13
DESERT

19
LUX DEVA

25
LUX GROTTA

29
LUX JATOBÁ

35
LUX JEBEL

39
KONCEPT

45
LUX LAURANTS

51
LINCOLN

57
MOLEANOS

63
NEBULA

69
LUX NOOR

73
PISA

79
PLAIN

81
TORANO

87
Get inspired...

89

EXPOSITORES Y CARACTERÍSTICAS TÉCNICAS

Display units & technical characteristics
Présentoirs et caractéristiques techniques



And the “Dramatic Interior” goes to...

Alejándonos del minimalismo y prestando especial atención al rol que juega la fuerza geológica, el diseño de interiores consigue crear una tendencia que no deja indiferente a nadie: Dramatic interior. Un movimiento que, influenciado principalmente por el neoclasicismo, se convierte en el impulso para proyectar espacios donde los mármoles y las piedras naturales sean los principales protagonistas. En esta tendencia, las canteras de mármol más prestigiosas del mundo, inspiran y dan lugar a diseños marmóreos con cortes sofisticados y colores exuberantes que, junto a piedras preciosas, convierten a estas piezas en el punto focal de cualquier estancia.

Así mismo, evocando al lujo y a la elegancia, el interiorismo crea espacios donde abunda la teatralidad y el dramatismo, y los avances tecnológicos y los diseños con granilla, logran que la cerámica reconquiste el mundo de la decoración y el interiorismo contemporáneo.

Con sus efectos de veteado, sus matices cromáticos y sus efectos brillantes, nace una colección que define notoriamente la tendencia de la que veníamos hablando.

Grandes diseños con altas prestaciones técnicas que permiten crear impactos visuales y juegos cromáticos en cualquier estancia donde pavimentos o revestimientos tomen el papel principal.

Shifting the focus from minimalism to mighty force of geology makes for an interior design trend guaranteed to get heads turning. Dramatic interior is a trend with an essentially neoclassical influence, inspiring spaces with natural marble and stone effects. Stone hewn from the world's most prestigious quarries are the origins of this trend, characterised by marble effect designs featuring sophisticated patterns and bright and beautiful colours which, together with the precious stone effects, will become the focal point of any room.

In an evocation of luxury and elegance, interior design creates dramatically theatrical spaces, applying state-of-the-art technologies and designs with granilla (a granular glaze) to reposition ceramic tiles at the forefront of contemporary interior design and decoration.

Subtle shading, veining and glossy effects are the hallmarks of seven series that together form a collection, the quintessence of the trend defined above.

Superb designs combined with cutting-edge technical features that together allow for stunning visual impacts and clever plays on colour that will look fabulous in any room where wall or floor tiles are a core decorative element.

En nous éloignant du minimalisme et en accordant une attention spéciale au rôle que joue la force géologique, le design d'intérieurs parvient à créer une tendance qui ne laisse personne indifférent : Dramatic interior. Un mouvement, principalement influencé par le néoclassicisme, qui insuffle l'élan pour projeter des espaces dans lesquels les marbres et les pierres naturelles ont le premier rôle. Dans cette tendance, les carrières de marbre les plus prestigieuses du monde inspirent et donnent naissance à des designs marbre avec des coupes sophistiquées et des couleurs exubérantes qui, associés à des pierres précieuses, font de ces carreaux le centre d'attention de tous les regards dans n'importe quelle pièce.

De plus, en évoquant le luxe et l'élégance, la décoration d'intérieur crée des espaces où abondent mise en scène et charge dramatique tandis que les avancées technologiques et les designs avec granilla (émaill en grain) permettent à la céramique de reconquérir le monde de la décoration et du design d'intérieurs contemporain.

Ses effets de veinure, ses nuances chromatiques et ses effets brillants donnent naissance à huit séries, et qui définit de façon notoire la tendance dont nous venons de parler.

De grands designs avec d'excellentes prestations techniques qui permettent de créer des impacts visuels et des jeux chromatiques dans n'importe quelle pièce en donnant le rôle principal aux carrelages de sol ou de mur.

CELLINI

DISEÑO SUAVE Y DIFERENTE

CELLINI, un homenaje al clásico mármol de los Calacatta Statuario, formado habitualmente por vetas expandidas que son consecuencia de una abundante concentración de minerales filosilicatos. Vetas finas y paralelas en diferentes tonos grises, que destacan sobre un fondo de color blanco puro.

Un diseño suave y diferente.

DISTINCTIVE GENTLE-LOOKING DESIGN

CELLINI is a tribute to classic Calacatta Statuary marble, whose surface is normally shot with thick veins due to its large concentrations of phyllosilicate minerals. Accompanying slender parallel veins in different shades of grey stand out against a dazzling white background, lending it a distinctive gentle-looking design.

DESIGN DOUX ET DIFFÉRENT

CELLINI, un hommage au marbre classique des Alpes apuanes, habituellement constitué de veines fruits d'une abondante concentration de phyllosilicates. Des veines fines et parallèles dans différents tons gris, qui se détachent sur un fond blanc pur. Un design doux et différent.



Rvto. / Wall / Rvtrm.: Cellini Blanco 120x260 Leviglass
Pvto. / Floor / Sol: Wells M. Ash 120x120



Rvto. / Wall / Rvrm.: Cellini Blanco 60x120 Leviglass
Pvto. / Floor / Sol: Cellini Blanco 120x120 Leviglass



Formatos / Sizes / Fomat

120x260 cm
47,24"x102,36"

6 mm

120x120 cm
47,24"x47,24"

60x60 cm
23,62"x23,62"

60x120 cm
23,62"x47,24"

75x150 cm
29,52"x59,05"

32,5x22,5 cm
12,79"x8,85"

30x30 (5x5) cm
11,81"x11,81"

CELLINI

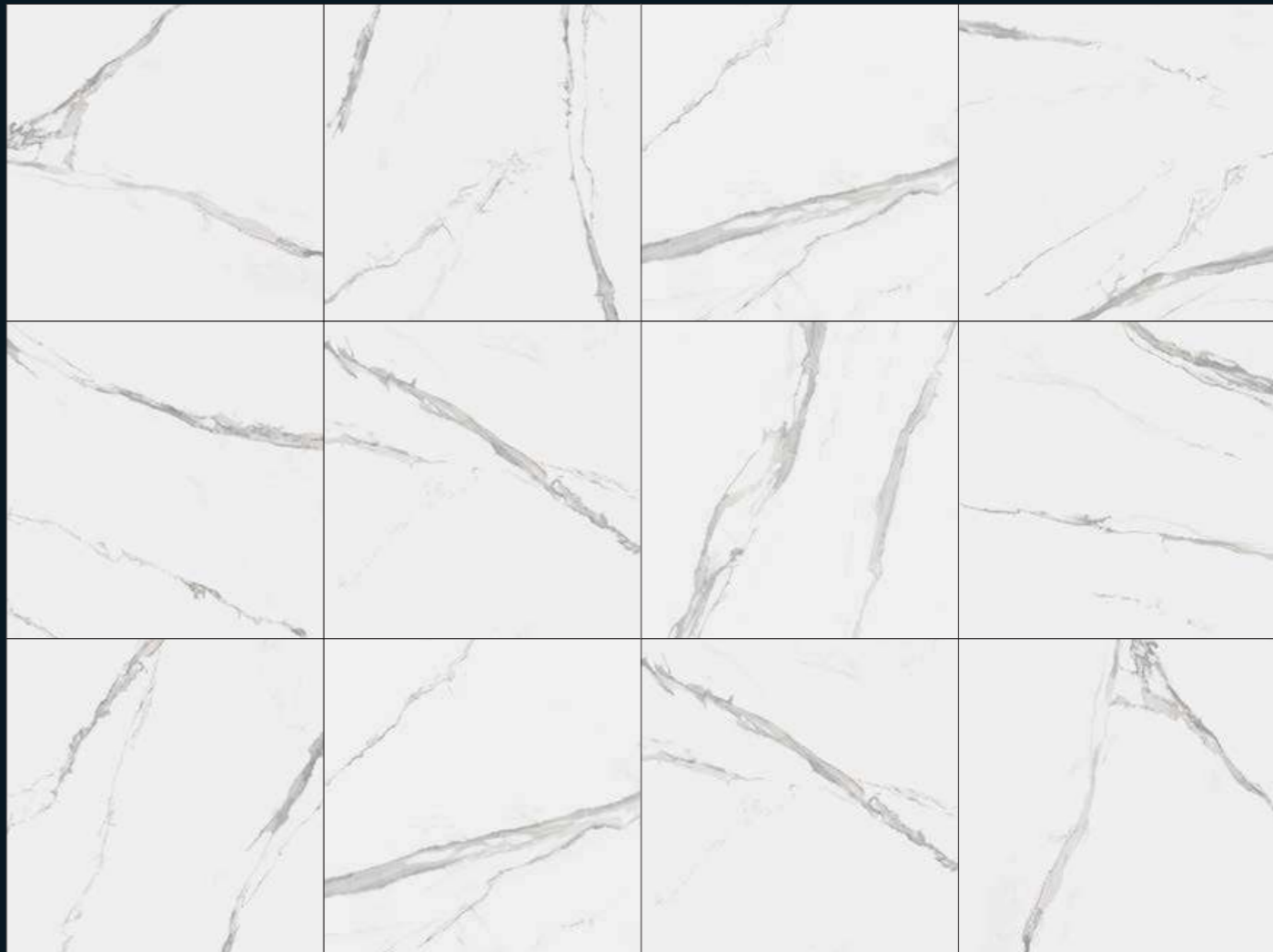

Empaquetado / Packaging / Emballage

Formato	pz/cj	m²/cj	cj/pl	m²/pl	kg/cj	kg/pl
75x150	1	1.13	40	45.20	28.00	1.184.00
60x120	2	1.44	32	46.08	34.50	1.129.00
120x120	1	1.44	36	51.84	38.40	1.422.40
60x60	4	1.44	30	43.20	30.00	920.00
32,5x22,5	9	-	-	-	13.50	-
30x30 (5)	11	1.00	42	42.00	23.00	986.00

Empaquetado / Packaging / Emballage

Formato	pz/pl	m²/pz	m²/pl	kg/pl
120x260	20	3.12	62.40	1.050.00

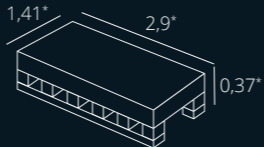

*Medidas en metros
*Dimensions in metres
*Dimensions en mètres

Cellini Blanco

Formato	Rec.	M	Code	Icon	Grado
120x260	Rec.	M300	054.200.0012.09556	LEV	6mm
120x260	Rec.	M204	052.200.0012.09556	MATT	6mm
75x150	Rec.	M114	004.350.0102.09556	LEV	10,5mm
60x120	Rec.	M96	004.869.0012.09556	LEV	10,5mm
120x120	Rec.	M150	004.120.0012.09556	LEV	10,7mm
60x60	Rec.	M61	004.840.0012.09556	LEV	9,5mm

Malla Cellini

Blanco	30x30 (5)	M235	038.281.0012.09556	LEV	9,5mm
Blanco	32,5x22,5	P46	038.297.0012.09556	LEV	9,5mm

Cellini M. Blanco

60x120	Rec.	M83	017.869.0012.10091	MATT	10,5mm
120x120	Rec.	M123	017.120.0012.10091	MATT	10,7mm
60x60	Rec.	M48	017.840.0012.10091	MATT	9,5mm

Malla Cellini M.

Blanco	30x30 (5)	M235	025.281.0012.10091	MATT	9,5mm
Blanco	32,5x22,5	P46	025.297.0012.10091	MATT	9,5mm

blanco

CR. LUX
GRES PORCELÁNICO RECTIFICADO-GRANILLA PULIDA
RECTIFIED PORCELAIN TILES-POLISHED GRANILLA
GRÈS CÉRAMÉ RECTIFIÉE - GRANILLA POLI

LEVIGLASS
GRES PORCELÁNICO ESMALTADO PULIDO RECTIFICADO
POLISHED GLAZED RECTIFIED PORCELAIN TILES
GRÈS CÉRAMÉ ÉMAILLÉ POLI RECTIFIÉE

COMPACGLASS
GRES PORCELÁNICO ESMALTADO RECTIFICADO
RECTIFIED GLAZED PORCELAIN TILES
GRÈS CÉRAMÉ ÉMAILLÉ RECTIFIÉE

DESERT

PURA ESENCIA JORDANA

Vetas discontinuas, gráciles, oscuras, pero destonificadas, son las protagonistas en **DESERT**. Un homenaje a la belleza de la piedra de Jordania que, con su fondo blanco cremoso y el vigor de su superficie, invita a crear espacios llenos de sofisticación y elegancia.

PURE JORDANIAN ESSENCE

Gracefully broken veining in dark yet shaded tones is the defining feature of **DESERT**, which extols the beauty of Jordanian stone, with its creamy white background and bold surface pattern. An invitation to create spaces filled with elegant sophistication that is impossible to resist.

PURE ESSENCE JORDANIENNE

Les veinures discontinues, gracieuses, sombres mais avec variation de tons sont les protagonistes de la série **DESERT**. Un hommage à la beauté de la pierre de Jordanie qui, avec son fond blanc crème et la vigueur de sa surface, invite à créer des espaces respirant la sophistication et l'élégance.

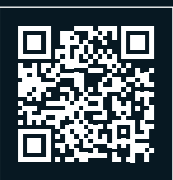

Rvto. / Wall / Rvtm.: Desert Natural 120x260 Leviglass
Pvto. / Floor / Sol: Argile Earth 90x90



Rvto. / Wall / Rvrm.: Desert Natural 120x260 - Rovere Brown 25x150
Pvto. / Floor / Sol: Argile Ivory 120x120



Formatos / Sizes / Fomat

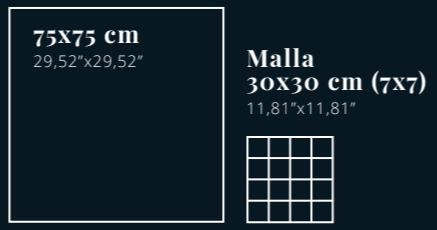
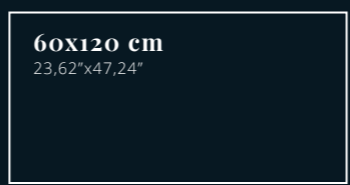
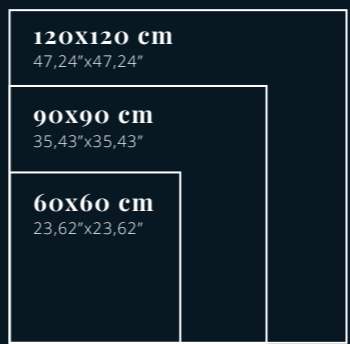

DESERT



CR. LUX
GRES PORCELÁNICO RECTIFICADO-GRANILLA PULIDA
RECTIFIED PORCELAIN TILES-POLISHED GRANILLA
GRÈS CÉRAMÉ RECTIFIÉE - GRANILLA POLI

LEVIGLASS
GRES PORCELÁNICO ESMALTADO PULIDO RECTIFICADO
POLISHED GLAZED RECTIFIED PORCELAIN TILES
GRÈS CÉRAMÉ ÉMAILLÉ POLI RECTIFIÉE



Empaquetado / Packaging / Emballage

Formato	pz/cj	m²/cj	cj/pl	m²/pl	kg/cj	kg/pl
75x150	1	1.13	40	45.20	28.00	1,184.00
60x120	2	1.44	32	46.08	34.50	1,129.00
120x120	1	1.44	36	51.84	38.40	1,422.40
90x90	2	1.62	27	43.74	40.00	1,110.00
75x75	3	1.69	30	50.70	41.20	1,256.00
60x60	4	1.44	30	43.20	30.00	920.00
32,5x22,5	9	-	-	-	13.50	-
30x30 (7)	11	1.00	42	42.00	23.10	990.20

Empaquetado / Packaging / Emballage

Formato	pz/pl	m²/pz	m²/pl	kg/pl
120x260	20	3.12	62.40	1,050.00

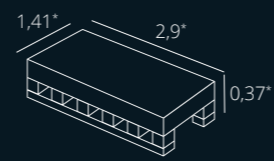

*Medidas en metros
*Dimensions in metres
*Dimensions en mètres

Desert Natural

Formato	Rec.	M	Código	Clase	Espesor
120x260	Rec.	M300	054.200.0102.04037	PEI 4	6mm
75x150	Rec.	M114	004.350.0102.04037	PEI 4	10,5mm
60x120	Rec.	M96	004.869.0102.04037	PEI 4	10,5mm
120x120	Rec.	M150	004.120.0102.04037	PEI 4	10,7mm
90x90	Rec.	M88	004.804.0102.04037	PEI 4	10,5mm
75x75	Rec.	M74	004.875.0102.04037	PEI 4	10,5mm
60x60	Rec.	M61	004.840.0102.04037	PEI 4	9,5mm

Malla Desert

Natural	30x30 (7)	M185	038.590.0102.04037	PEI 4	9,5mm
Natural	32,5x22,5	P46	038.297.0102.04037	PEI 4	9,5mm

natural

LUX DEVA

OSCURIDAD DE LA NOCHE

LUX DEVA es la oscuridad de la noche, un fondo negro iluminado por radiantes vetas blancas.

Un mármol noble y elegante que nace en las canteras del País Vasco. Deva, reproduce al negro Marquina y saca a relucir todas las mezclas de calcita blanca y fósiles propios de este diseño tan espectacular.

DARKNESS OF NIGHT

LUX DEVA conjures up the darkness of night, with a black background lit up by radiant white veins. All the beauty of black Marquina marble, a fine-quality elegant stone quarried in the Basque Country, has been carefully reproduced, highlighting the mixes of white calcite and fossils found in its spectacular design.

L'OBSCURITÉ DE LA NUIT

LUX DEVA est l'obscurité de la nuit, un fond noir éclairé par de radiantes veines blanches.

Un marbre noble et élégant né dans les carrières du Pays basque. Deva reproduit le noir Marquina et met en avant tous les mélanges de calcite blanche et de fossiles propres à ce design si spectaculaire.



Rvto. / Wall / Rvtrm.: Lux Deva Nero 120x260 - Oldmanor Tabaco 25x150
Pvto. / Floor / Sol: Lincoln White 120x120 Leviglass



Rvto. / Wall / Rvtn.: Lux Deva Nero 120x260
Pvto. / Floor / Sol: Cromat Gris 120x120 Rectificado



nero

Formatos / Sizes / Fomat

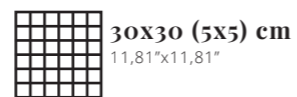
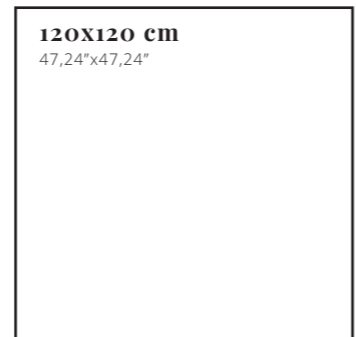

LUX DEVA

CR. LUX
GRES PORCELÁNICO ESMALTADO PULIDO RECTIFICADO
POLISHED GLAZED RECTIFIED PORCELAIN TILES
GRÈS CÉRAME ÉMAILLÉ POLI RECTIFIÉE

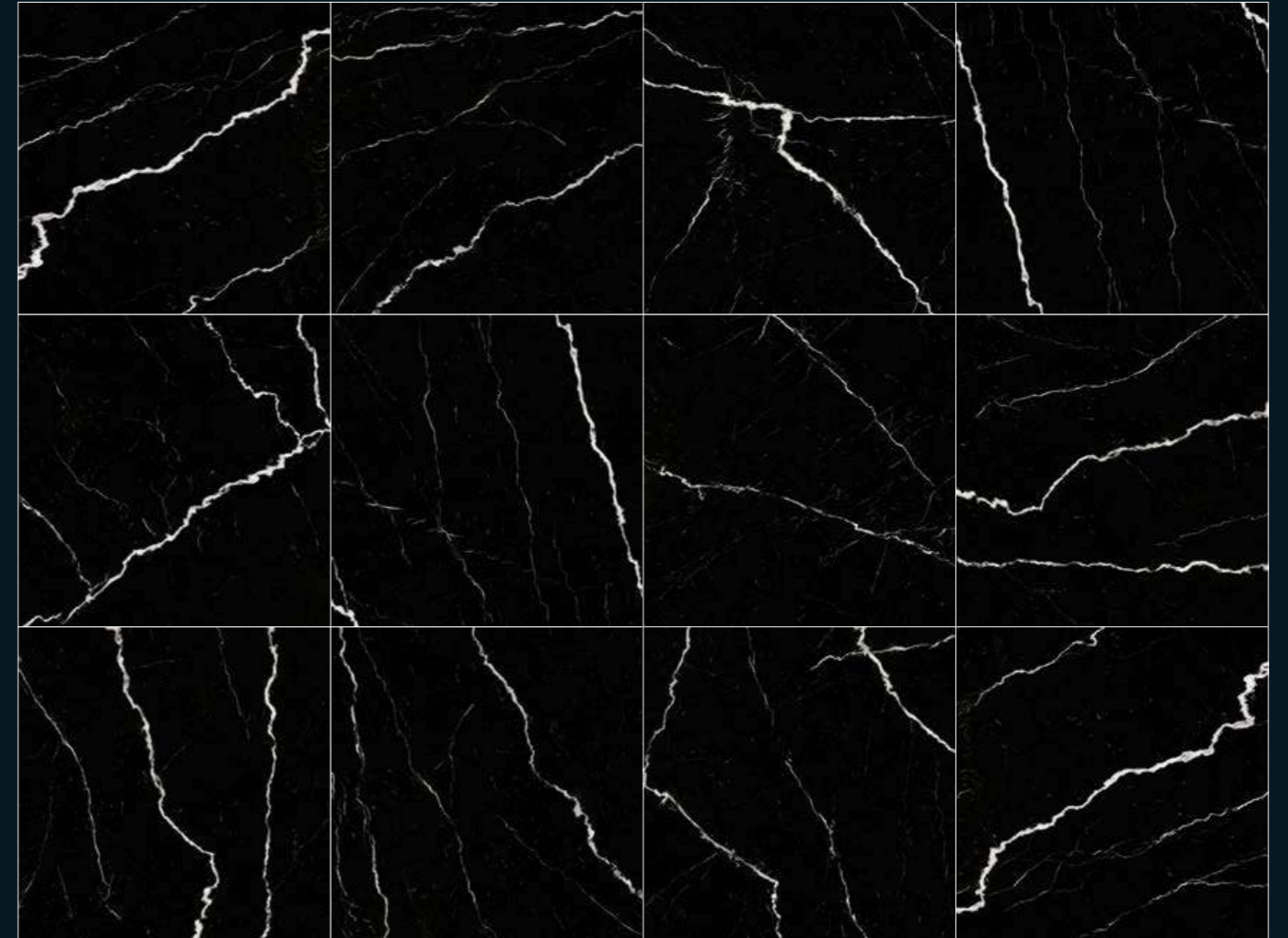

Empaquetado / Packaging / Emballage

Formato	pz/cj	m²/cj	cj/pl	m²/pl	kg/cj	kg/pl
60x120	2	1.44	32	46.08	34.50	1,129.00
120x120	1	1.44	36	51.84	38.40	1,422.40
32,5x22,5	9	-	-	-	13.50	-
30x30 (5)	11	1.00	42	42.00	23.00	986.00

Empaquetado / Packaging / Emballage

Formato	pz/pl	m²/pz	m²/pl	kg/pl
120x260	20	3.12	62.40	1,050.00

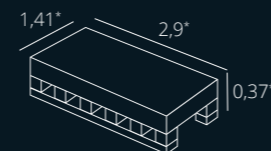

*Medidas en metros
*Dimensions in metres
*Dimensions en mètres

Lux Deva Nero

PEI 3

● 120x260	Rec.	M300	054.200.0215.09564		6mm
● 60x120	Rec.	M132	046.869.0215.09564		10,5mm
● 120x120	Rec.	M185	046.120.0215.09564		10,7mm

Malla Lux Deva

● Nero	32,5x22,5	P46	086.297.0215.09564		10,5mm
● Nero	30x30 (5)	M235	086.281.0215.09564		10,5mm

LUX GROTTA

CALACATTA FIORITO

LUX GROTTA llega directamente de las celeberrimas canteras de los Alpes Apuanos. Un lienzo sobre el que cabalgan vetas de intensos tonos negros y dorados. Manchas de acuarela que emergen en distintas formas, tamaños y direcciones. De todas las variedades del mármol, la del Calacatta es una de las más demandadas por su belleza y singularidad. Grotta es un homenaje al Calacatta Fiorito, un mármol que se extrae de una sola cantera que produce grandes bloques en cantidades limitadas. El mármol aporta un refinamiento delicado, pero si se opta por la originalidad, sin duda, Grotta es imprescindible.

CALACATTA FIORITO

LUX GROTTA comes directly from the famous quarries of the Apuan Alps. A canvas upon which veins of intense black and golden tones cross. Watercolour patches that emerge in different shapes, sizes and directions. Of all the varieties of marble, Calacatta is one of the most sought-after for its beauty and uniqueness. Grotta is a tribute to the Calacatta Fiorito, a marble that is extracted from a single quarry that produces large blocks in limited quantities. Marble provides a delicate look of refinement, but if originality is what you are really after, then Grotta is a must-have.

CALACATTA FIORITO

LUX GROTTA nous arrive en direct des célèbres carrières des Alpes Apuanes. Une toile sur laquelle s'élancent des veines aux intenses nuances de noir et doré, ponctuée de touches d'aquarelle qui s'épanouissent sous différentes formes et tailles, et qui partent dans tous les sens. Entre toutes les variétés de marbre, celle issue des carrières de Calacatta connaît un grand succès grâce à sa beauté et sa singularité. Grotta rend hommage au Calacatta Fiorito, un marbre extrait d'une seule carrière, qui produit de grands blocs en quantités limitées. Le marbre confère un raffinement délicat. Cependant, si l'on fait le choix de l'originalité, Grotta constitue indubitablement une option indispensable.





oro

27

Formatos / Sizes / Fomat

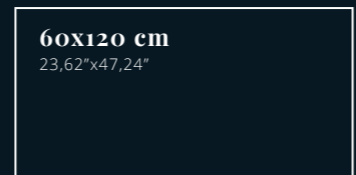
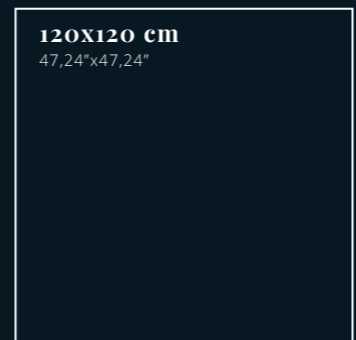

LUX GROTTA



CR. LUX
GRES PORCELÁNICO RECTIFICADO-GRANILLA PULIDA
RECTIFIED PORCELAIN TILES-POLISHED GRANILLA
GRÈS CÉRAMÉ RECTIFIÉE - GRANILLA POLI



Empaquetado / Packaging / Emballage

Formato	pz/cj	m²/cj	cj/pl	m²/pl	kg/cj	kg/pl
60x120	2	1.44	32	46.08	34.50	1,129.00
120x120	1	1.44	36	51.84	38.40	1,422.40
32,5x22,5	9	-	-	-	13.50	-
30x30 (5)	11	1.00	42	42.00	23.00	986.00

Empaquetado / Packaging / Emballage

Formato	pz/pl	m²/pz	m²/pl	kg/pl
120x260	20	3.12	62.40	1,050.00

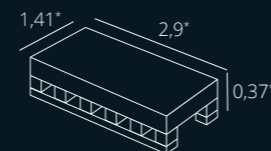

*Medidas en metros
*Dimensions in metres
*Dimensions en mètres

Lux Grotta Oro

Formato	Rec.	M	Código	PEI	Gr. 4
120x260	Rec.	M300	054.200.0032.09099	6mm	
60x120	Rec.	M132	046.869.0032.09099	10,5mm	
120x120	Rec.	M185	046.120.0032.09099	10,7mm	

Malla Lux Grotta

Oro	32,5x22,5	P46	086.297.0032.09099	10,5mm
Oro	30x30 (5)	M235	086.281.0032.09099	10,5mm

LUX JATOBÁ

COCOA BROWN

LUX JATOBÁ resume la belleza y sinuosidad de la cuarcita brasileña. Le protagonizan sus curvas en tonos suaves y la profundidad de su color marrón cacao con reminiscencias grisáceas. Detalles que convierten a esta pieza en la joya de cualquier estancia.

COCOA BROWN

LUX JATOBÁ embodies all the beauty and sinuosity of Brazilian quartzite. Soft-coloured waves are combined with deep cocoa brown, shot with a hint of grey. All these details are guaranteed to draw all eyes wherever Jatobá is used.

COCOA BROWN

LUX JATOBÁ résume la beauté et la sinuosité du quartzite brésilien. Il se caractérise par ses courbes dans des tons doux et la profondeur de sa couleur cacao avec des réminiscences grisâtres. Des détails qui font de cette pièce le joyau de tous les espaces.



Rvto. / Wall / Rvtm.: Jatobá Brown 120x260
Pvto. / Floor / Sol: Argile Ivory 120x120



Rvto. / Wall / Rvrm.: Jatobá Brown 120x260
Pvto. / Floor / Sol: Mosa Sable 90x90



Formatos / Sizes / Fomat

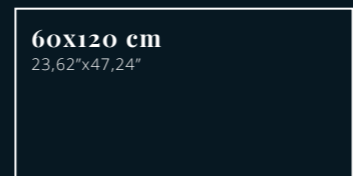
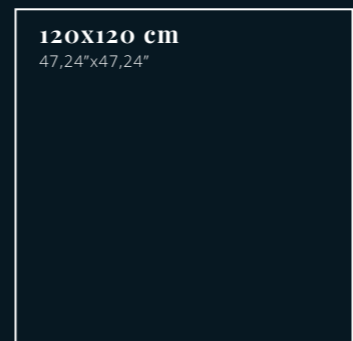
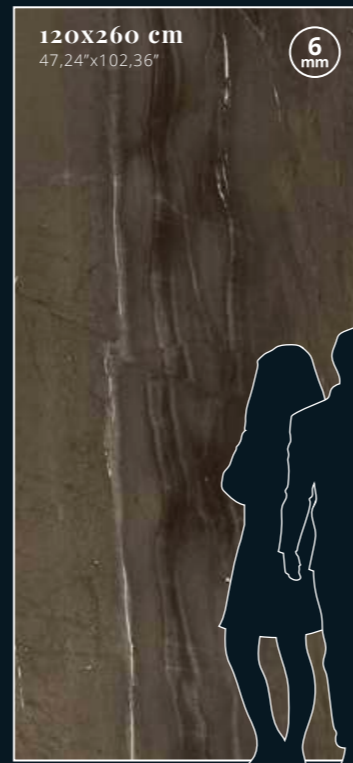

LUX JATOBÁ

CR. LUX
GRES PORCELÁNICO ESMALTADO PULIDO RECTIFICADO
POLISHED GLAZED RECTIFIED PORCELAIN TILES
GRÉS CÉRAMÉ ÉMAILLÉ POLI RECTIFIÉE



Empaquetado / Packaging / Emballage

Formato	pz/cj	m²/cj	cj/pl	m²/pl	kg/cj	kg/pl
60x120	2	1.44	32	46.08	34.50	1,129.00
120x120	1	1.44	36	51.84	38.40	1,422.40
32,5x22,5	9	-	-	-	13.50	-
30x30 (5)	11	1.00	42	42.00	23.00	986.00

Empaquetado / Packaging / Emballage

Formato	pz/pl	m²/pz	m²/pl	kg/pl
120x260	20	3.12	62.40	1,050.00

Lux Jatobá Brown

	Rec.	M	086.297.0109.09565	PEI 3	
● 120x260	Rec.	M300	054.200.0109.09565	6mm	
● 60x120	Rec.	M132	046.869.0109.09565	10,5mm	
● 120x120	Rec.	M185	046.120.0109.09565	10,7mm	

Malla Lux Jatobá

● Brown	32,5x22,5	P46	086.297.0109.09565	10,5mm
● Brown	30x30 (5)	M235	086.281.0109.09565	10,5mm

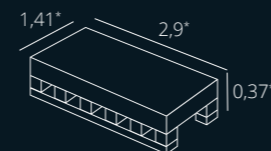

*Medidas en metros
*Dimensions in metres
*Dimensions en mètres

LUX JEBEL

MAJESTUOSO E HIPNÓTICO

Como un desierto oscuro y profundo, deslumbrado por líneas verticales de color oro iridiscente; así es el alma de **LUX JEBEL**, majestuoso e hipnótico. Un mármol que nace en Túnez y homenajea al Sahara Noir.

MAJESTIC AND HYPNOTIC

Like a deep, dark desert, dazzled by vertical golden lines; that is the soul of **LUX JEBEL**, majestic and hypnotic. Marble from Tunisia that pays tribute to the Black Sahara.

MAJESTUEUX ET HYPNOTIQUE

Comme un désert sombre et profond, ébloui par des lignes verticales de couleur or iridescent ; telle est l'âme de **LUX JEBEL**, majestueux et hypnotique. Un marbre né en Tunisie qui rend hommage au Sahara Noir.





Formatos / Sizes / Fomat

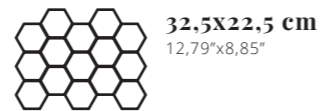
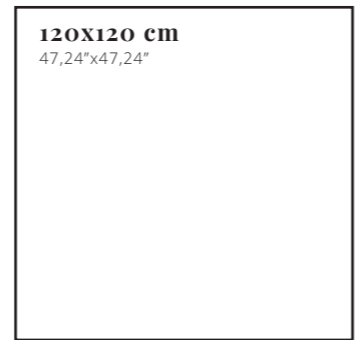

LUX JEBEL

CR. LUX
GRES PORCELÁNICO RECTIFICADO-GRANILLA PULIDA
RECTIFIED PORCELAIN TILES-POLISHED GRANILLA
GRÈS CÉRAMÉ RECTIFIÉE - GRANILLA POLI

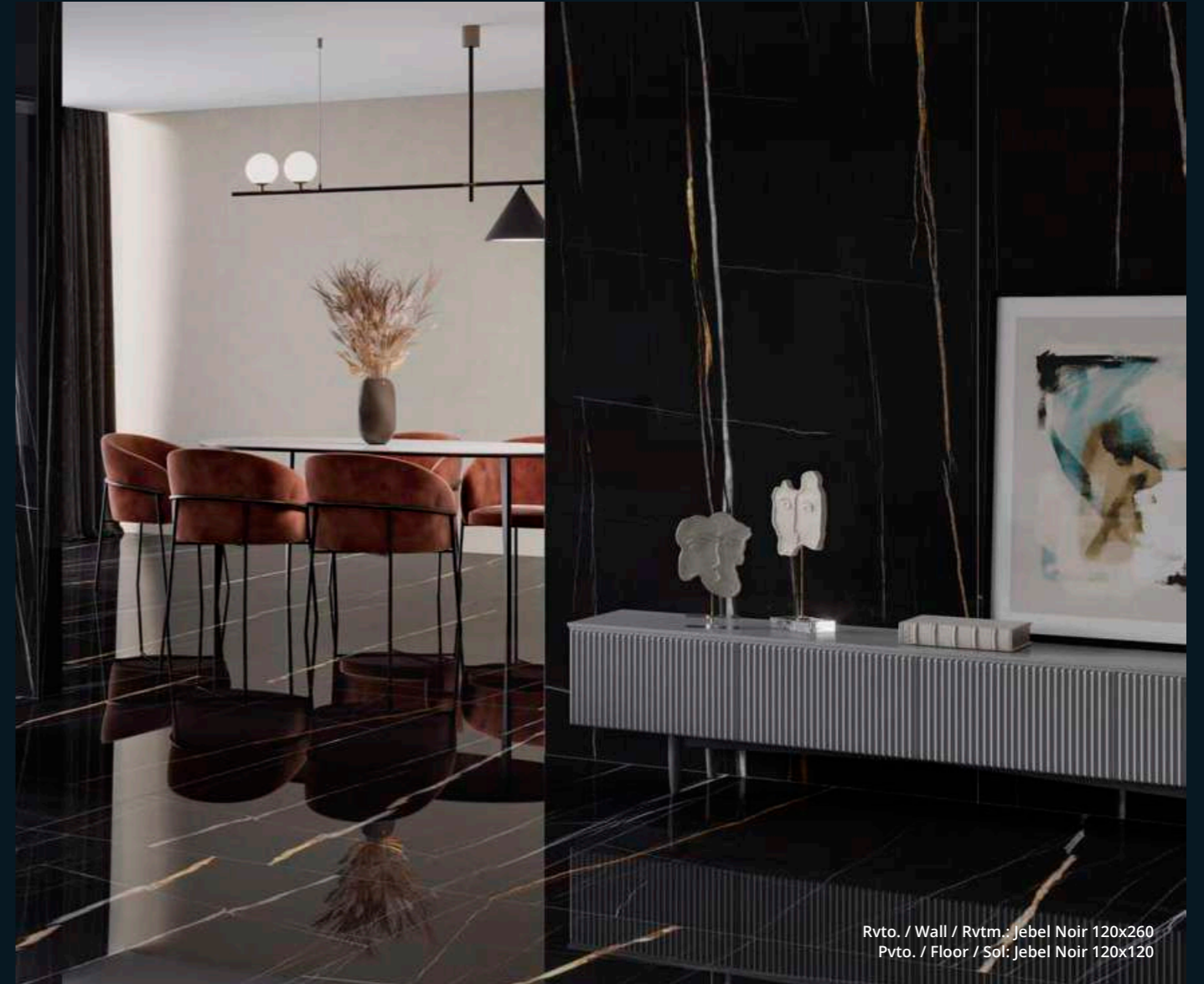

Rvto. / Wall / Rvtm.: Jebel Noir 120x260
Pvto. / Floor / Sol: Jebel Noir 120x120

Empaquetado / Packaging / Emballage

Formato	pz/cj	m²/cj	cj/pl	m²/pl	kg/cj	kg/pl
60x120	2	1.44	32	46.08	34.50	1,129.00
120x120	1	1.44	36	51.84	38.40	1,422.40
32,5x22,5	9	-	-	-	13.50	-
30x30 (5)	11	1.00	42	42.00	23.00	986.00

Empaquetado / Packaging / Emballage

Formato	pz/pl	m²/pz	m²/pl	kg/pl
120x260	20	3.12	62.40	1,050.00

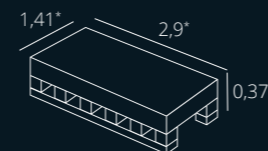

*Medidas en metros
*Dimensions in metres
*Dimensions en mètres

Lux Jebel Noir

Formato	Rec.	M300	054.200.0535.10409	PEI 3
120x260	Rec.	M300	054.200.0535.10409	6mm
60x120	Rec.	M132	046.869.0535.10409	10,5mm
120x120	Rec.	M185	046.120.0535.10409	10,7mm

Malla Lux Jebel

Noir	32,5x22,5	P46	086.297.0535.10409	10,5mm
Noir	30x30 (5)	M235	086.281.0535.10409	10,5mm

KONCEPT

LA ELEGANCIA DEL CEMENTO COMO BASE COMBINATORIA

De inspiración minimalista, **KONCEPT** reproduce el diseño del cemento como base para crear interiores exclusivos en los que la sintonía cromática y las posibilidades combinatorias alcanzan su máxima expresión. Una colección que se completa con cinco series más, configurando una unidad decorativa superior de texturas evocadoras.

THE ELEGANCE OF CEMENT AS A BASE FOR NUMEROUS COMBINATIONS

Inspired by minimalism, **KONCEPT** takes the design of cement as the foundation for creating exclusive interiors where finely balanced colour and potential combinations know no bounds. This collection is accompanied by five series to offer a superior quality decorative ensemble of evocative textures.

L'ÉLÉGANCE DU CIMENT COMME BASE POUR LES COMBINAISONS

D'inspiration minimaliste, **KONCEPT** reproduit le design du ciment comme base pour créer des intérieurs exclusifs, où l'harmonie chromatique et les possibilités combinatoires atteignent leur expression maximale. Une collection qui se complète par cinq autres séries, configurant une unité décorative supérieure aux textures évocatrices. Son design ne termine pas avec chaque pièce, car sa singularité réside dans sa coordination chromatique, mélange de formats et combinaison de textures.



Rvto. / Wall / Rvfm.: Konzept Nacar 120x260
Pvto. / Floor / Sol: Montpellier Graphite 120x120



Rvto. / Wall / Rvrm.: Konzept Nacar 120x260
Pvto. / Floor / Sol: Montpellier Earth 120x120

Formatos / Sizes / Fomat

120x260 cm
47,24"x102,36"

6 mm



120x120 cm
47,24"x47,24"

60x60 cm
23,62"x23,62"

60x120 cm
23,62"x47,24"

30x60 cm
11,81"x23,62"

75x75 cm
29,52"x29,52"

Malla 30x30 cm (7x7)
11,81"x11,81"

KONCEPT



COMPACTTO PEDRA

COMPACTTO PEDRA ADZ.



COMPACTTO PEDRA SEMIPULIDO

COMPACTTO PEDRA SEMIPULIDO
GRES PORCELÁNICO SEMIPULIDO RECTIFICADO
RECTIFIED SEMIPOLISHED PORCELAIN TILES
GRÉS CÉRAME SEMIPOLI RECTIFIÉE

COMPACTTO PEDRA
GRES PORCELÁNICO RECTIFICADO
RECTIFIED PORCELAIN TILES
GRÉS CÉRAME RECTIFIÉE



Rvto. / Wall / Rvtm.: Konzept Nacar 120x260
Pvto. / Floor / Sol: Montpellier Earth 120x120

nacar

Konzept Nacar

● 120x260	Rec.	M204	052.200.0030.02967	MATT	6mm
● 60x120	Rec.	M92	035.869.0030.02967	MATT	10,5mm
● 60x120	Rec.	M105	039.869.0030.02967	SP	10,5mm
● 30x60	Rec.	M54	035.450.0030.02967	MATT	9,5mm
● 30x60	Rec.	M63	039.450.0030.02967	SP	9,5mm
● 120x120	Rec.	M128	035.120.0030.02967	MATT	10,7mm
● 120x120	Rec.	M145	039.120.0030.02967	SP	10,7mm
● 75x75	Rec.	M72	035.875.0030.02967	MATT	10,5mm
● 75x75	Adz.	M76	035.875.0030.00225	MATT	10,5mm
● 75x75	Rec.	M83	039.875.0030.02967	SP	10,5mm
● 60x60	Rec.	M54	035.840.0030.02967	MATT	9,5mm
● 60x60	Adz.	M58	035.840.0030.00225	MATT	9,5mm
● 60x60	Rec.	M65	039.840.0030.02967	SP	9,5mm

Konzept Argent

● 120x260	Rec.	M204	052.200.0135.02967	MATT	6mm
● 60x120	Rec.	M92	035.869.0135.02967	MATT	10,5mm
● 60x120	Rec.	M105	039.869.0135.02967	SP	10,5mm
● 30x60	Rec.	M54	035.450.0135.02967	MATT	9,5mm
● 30x60	Rec.	M63	039.450.0135.02967	SP	9,5mm
● 120x120	Rec.	M128	035.120.0135.02967	MATT	10,7mm
● 120x120	Rec.	M145	039.120.0135.02967	SP	10,7mm
● 75x75	Rec.	M72	035.875.0135.02967	MATT	10,5mm
● 75x75	Adz.	M76	035.875.0135.00225	MATT	10,5mm
● 75x75	Rec.	M83	039.875.0135.02967	SP	10,5mm
● 60x60	Rec.	M54	035.840.0135.02967	MATT	9,5mm
● 60x60	Adz.	M58	035.840.0135.00225	MATT	9,5mm
● 60x60	Rec.	M65	039.840.0135.02967	SP	9,5mm

Empaquetado / Packaging / Emballage

Formato	pz/pl	m²/pz	m²/pl	kg/pl
120x260	20	3.12	62.40	1,050.00

Empaquetado / Packaging / Emballage

Formato	pz/cj	m²/cj	cj/pl	m²/pl	kg/cj	kg/pl
60x120	2	1.44	32	46.08	34.50	1,129.00
30x60	6	1.08	48	51.84	23.00	1,124.00
120x120	1	1.44	36	51.84	38.40	1,422.40
75x75	3	1.69	30	50.70	41.20	1,256.00
60x60	4	1.44	30	43.20	30.00	920.00
30x30 (7)	11	1.00	42	42.00	23.10	990.20

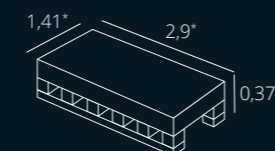

*Medidas en metros
*Dimensions in metres
*Dimensions en mètres

argent

LUX LAURANTS

EMPODERADO Y ELEGANTE

Sobre un fondo oscuro color cacao destacan unas vetas doradas y color tierra que dan forma a **LUX LAURANTS**, una serie que emula el clásico mármol Saint Laurent, perfecto para crear un punto focal en los interiores más exigentes.

EMPOWERED AND ELEGANT

Earth tone and golden veining stand out against a dark cacao background in **LUX LAURANTS**, a series reminiscent of the classic Saint Laurent marble, just the thing for creating a focal point in very special interiors.

PUISSANCE ET ÉLÉGANCE

Des veinures dorées et couleur terre sont mises en valeur sur un fond sombre couleur cacao et donnent naissance à **LUX LAURANTS**, une série qui reproduit le marbre classique Saint Laurent, idéal pour créer un centre d'attention au sein des intérieurs les plus exigeants.



Rvto. / Wall / Rvtrm.: Lux Laurants Brown 120x260 - Rovere Brown 25x150
Pvto. / Floor / Sol: Argile Ivory 120x120



Rvto. / Wall / Rvrm.: Lux Laurants Brown 120x260
Pvto. / Floor / Sol: Mosa Sable 90x90



Formatos / Sizes / Fomat



120X120 cm
47,24"x47,24"

60X120 cm
23,62"x47,24"

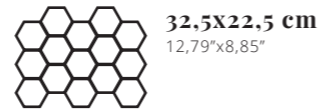

LUX LAURANTS

CR. LUX
GRES PORCELÁNICO ESMALTADO PULIDO RECTIFICADO
POLISHED GLAZED RECTIFIED PORCELAIN TILES
GRÉS CÉRAME ÉMAILLÉ POLI RECTIFIÉE

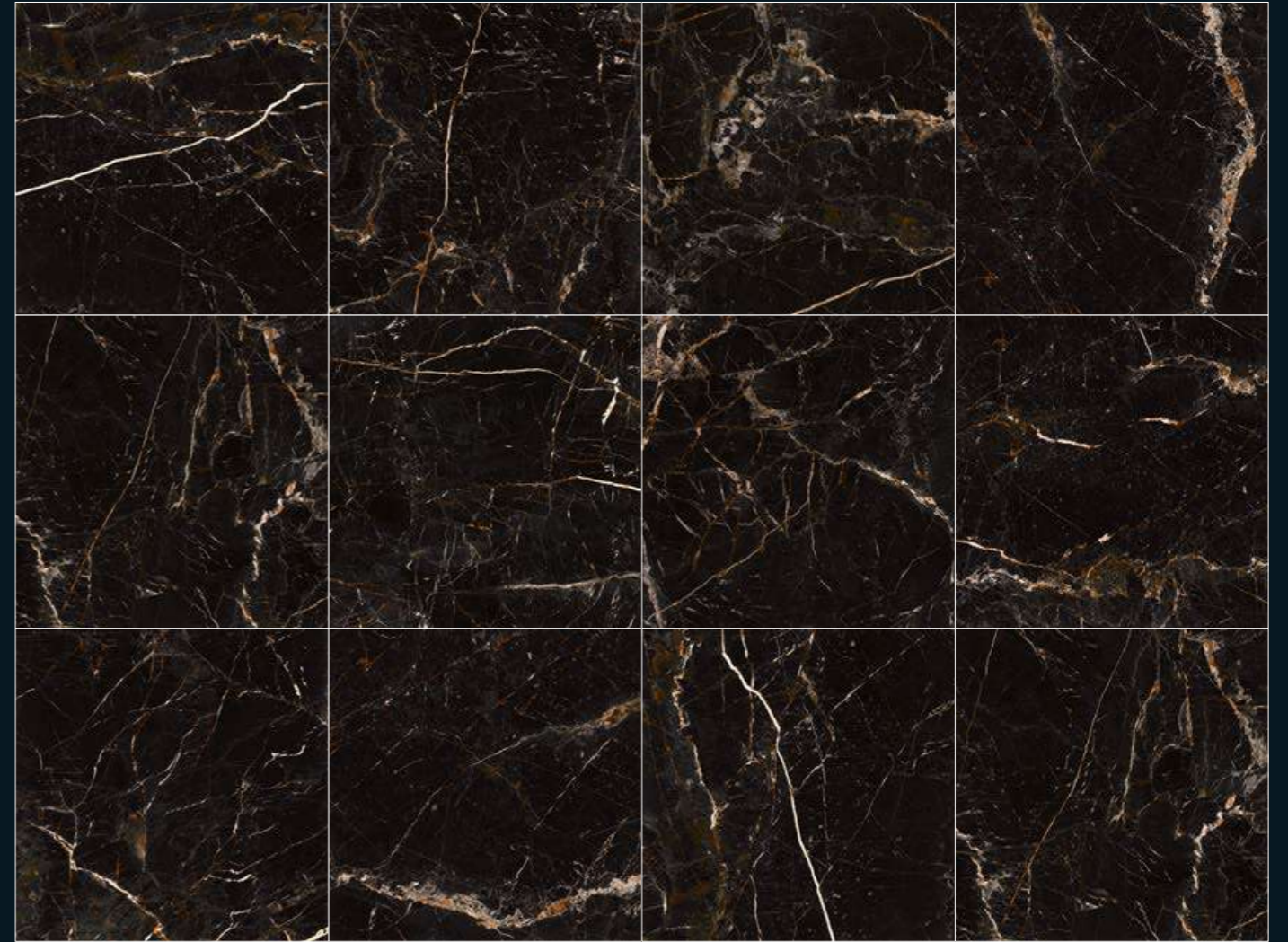

Empaquetado / Packaging / Emballage

Formato	pz/cj	m²/cj	cj/pl	m²/pl	kg/cj	kg/pl
60x120	2	1.44	32	46.08	34.50	1,129.00
120x120	1	1.44	36	51.84	38.40	1,422.40
32,5x22,5	9	-	-	-	13.50	-
30x30 (5)	11	1.00	42	42.00	23.00	986.00

Empaquetado / Packaging / Emballage

Formato	pz/pl	m²/pz	m²/pl	kg/pl
120x260	20	3.12	62.40	1,050.00

Lux Laurants Brown

Formato	Rec.	M300	054.200.0109.05151	PEI 3	6mm
60x120	Rec.	M132	046.869.0109.05151	10,5mm	
120x120	Rec.	M185	046.120.0109.05151	10,7mm	

Malla Lux Laurants

Brown	32,5x22,5	P46	086.297.0109.05151	10,5mm
Brown	30x30 (5)	M235	086.281.0109.05151	10,5mm

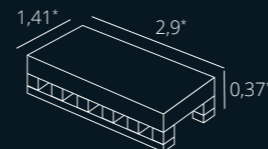

*Medidas en metros
*Dimensions in metres
*Dimensions en mètres

LINCOLN

ESENCIA AMERICANA

De origen estadounidense, y protagonista del Lincoln Memorial Centre, construido en 1900 en Washington, este mármol blanco es homenajeado con nuestra serie **LINCOLN**. Un diseño icónico por sus especiales vetas color humo de estilo Calacatta que consiguen crear un clásico capaz de dar un toque vanguardista a cualquier estancia.

AMERICAN ESSENCE

LINCOLN pays tribute to the white United States marble used to make the Lincoln Memorial Centre in 1900. Its iconic design stands out for its smoke-coloured veins in the style of Calacatta marble. A classic series able to bring an innovative appeal to living spaces of all kinds.

ESSENCE D'AMÉRIQUE

Originaire d'Amérique du Nord, et matériau principal du Lincoln Memorial Centre construit en 1900 à Washington, ce marbre blanc est l'inspiration de notre série **LINCOLN**. Un design iconique de par ses veines couleur fumée de style Calacatta réussissant à créer un classique capable d'apporter une touche avant-gardiste à toute sorte d'espace.





Rvto. / Wall / Rvtrm.: Lincoln White 120x260
Pvto. / Floor / Sol: Wells M. Ash 60x120



white

Formatos / Sizes / Fomat

120x260 cm
47,24"x102,36"



120x120 cm
47,24"x47,24"

90x90 cm
35,43"x35,43"

60x60 cm
23,62"x23,62"

60x120 cm
23,62"x47,24"

30x60 cm
11,81"x23,62"

19,8x22,8 cm
7,79"x8,97"

9x30 cm
3,54"x11,81"

Malla
30x30 cm (7x7)
11,81"x11,81"

32,5x22,5 cm
12,79"x8,85"

LINCOLN



Empaquetado / Packaging / Emballage

Formato	pz/cj	m²/cj	cj/pl	m²/pl	kg/cj	kg/pl
60x120	2	1.44	32	46.08	35.70	1,167.40
30x60	6	1.08	48	51.84	23.00	1,124.00
120x120	1	1.44	36	51.84	38.40	1,422.40
90x90	2	1.62	27	43.74	40.00	1,110.00
60x60	4	1.44	30	43.20	30.00	920.00
19,8x22,8	24	0.84	48	40.32	18	884.00
9x30	40	1.08	48	51.84	25.00	1,220.00
32,5x22,5	9	-	-	-	13.50	-
30x30 (7x7)	11	1.00	42	42.00	23.10	990.20

Empaquetado / Packaging / Emballage

Formato	pz/pl	m²/pz	m²/pl	kg/pl
120x260	20	3.12	62.40	1,050.00

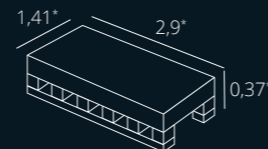

*Medidas en metros
*Dimensions in metres
*Dimensions en mètres

CR. LUX
GRES PORCELÁNICO RECTIFICADO-GRANILLA PULIDA
RECTIFIED PORCELAIN TILES-POLISHED GRANILLA
GRÈS CÉRAMÉ RECTIFIÉE - GRANILLA POLI

LEVIGLASS
GRES PORCELÁNICO ESMALTADO PULIDO RECTIFICADO
POLISHED GLAZED RECTIFIED PORCELAIN TILES
GRÈS CÉRAMÉ ÉMAILLÉ POLI RECTIFIÉE

COMPACGLASS
GRES PORCELÁNICO ESMALTADO RECTIFICADO
RECTIFIED GLAZED PORCELAIN TILES
GRÈS CÉRAMÉ ÉMAILLÉ RECTIFIÉE

Lincoln White

Formato	Rec.	M	Code	Clasificación	Grueso
120x260	Rec.	M300	054.200.0108.05978	PEI 4	6mm
60x120	Rec.	M96	004.869.0108.05978	PEI 4	10,5mm
30x60	Rec.	M61	004.450.0108.05978	PEI 4	9,5mm
120x120	Rec.	M150	004.120.0108.05978	PEI 4	10,7mm
90x90	Rec.	M88	004.804.0108.05978	PEI 4	10,5mm
60x60	Rec.	M61	004.840.0108.05978	PEI 4	9,5mm
9x30	Rec.	M136	038.137.0108.05978	PEI 4	9,5mm

Malla Lincoln

White	32,5x22,5	P46	038.297.0108.05978	PEI 4	9,5mm
White	30x30 (7)	M185	038.590.0108.05978	PEI 4	9,5mm

Lincoln M. White

Formato	Rec.	M	Code	Clasificación	Grueso
30x60	Rec.	M48	017.450.0108.10092	PEI 4	9,5mm
60x60	Rec.	M48	017.840.0108.10092	PEI 4	9,5mm
19,8x22,8	Rec.	M74	015.292.0108.10092	PEI 4	10mm
9x30	Rec.	M118	041.137.0108.10092	PEI 4	9,5mm

Malla Lincoln M.

White	32,5x22,5	P46	025.297.0108.10092	PEI 4	9,5mm
White	30x30 (7)	M185	025.590.0108.10092	PEI 4	9,5mm



MOLEANOS

AIRE DE EXCLUSIVIDAD

De origen portugués. El diseño de esta piedra caliza destaca por la presencia de pequeños fósiles que quedan a la vista en forma de manchas oscuras. Una pieza perfecta para aportar serenidad y exclusividad a cualquier proyecto.

AIR OF EXCLUSIVE

Inspired by a limestone of Portuguese origin, dotted with tiny fossils that form dark stains on the surface, **Moleanos** brings a soothing air of exclusive distinction to projects of all kinds.

AIR D'EXCLUSIVITÉ

D'origine portugaise. Le design de cette pierre calcaire se distingue par la présence de petits fossiles, qui apparaissent sous forme de taches sombres. Une pièce parfaite pour apporter sérénité et exclusivité à tous les projets.



Rvto. / Wall / Rvtrm.: Moleanos Sand 120x260
Pvto. / Floor / Sol: Belgio Gris 120x120



Rvto. / Wall / Rvtm.: Moleanos Pearl 120x260 - Cellini Blanco 120x260
Pvto. / Floor / Sol: Moleanos Pearl 120x120



pearl

sand

Formatos / Sizes / Fomat

120x260 cm
47,24"x102,36"

6 mm



120x120 cm
47,24"x47,24"

60x60 cm
23,62"x23,62"

60x120 cm
23,62"x47,24"

MOLEANOS

DECORSTONE
GRES PORCELÁNICO RECTIFICADO
RECTIFIED PORCELAIN TILES
GRÉS CÉRAME RECTIFIÉE



Rvto. / Wall / Rvtrn.: Moleanos Sand 120x260 - Konzept Nacar 120x260
Pvto. / Floor / Sol: Moleanos Sand 120x120

Empaquetado / Packaging / Emballage

Formato	pz/cj	m²/cj	cj/pl	m²/pl	kg/cj	kg/pl
60x120	2	1.44	32	46.08	34.50	1,129.00
120x120	1	1.44	36	51.84	38.40	1,422.40
60x60	4	1.44	30	43.20	30.00	920.00

Empaquetado / Packaging / Emballage

Formato	pz/pl	m²/pz	m²/pl	kg/pl
120x260	20	3.12	62.40	1,050.00

Moleanos Pearl

● 120x260	Rec.	M204	052.200.0169.09587		6mm
● 60x120	Rec.	M83	017.869.0169.09587		10,5mm
● 120x120	Rec.	M123	017.120.0169.09587		10,7mm
● 60x60	Rec.	M48	017.840.0169.09587		9,5mm

Moleanos Sand

● 120x260	Rec.	M204	052.200.0119.09587		6mm
● 60x120	Rec.	M83	017.869.0119.09587		10,5mm
● 120x120	Rec.	M123	017.120.0119.09587		10,7mm
● 60x60	Rec.	M48	017.840.0119.09587		9,5mm

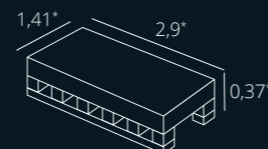

*Medidas en metros
*Dimensions in metres
*Dimensions en mètres

NEBULA

SKYLINE WHITE

Un diseño que recuerda a dunas desérticas en tonos café sobre un fondo blanco cremoso.

NEBULA recrea al singular mármol Skyline White, en el que destaca la singularidad de sus vetas largas y difuminadas en perpetuo movimiento.

SKYLINE WHITE

With a design evocative of coffee-coloured desert dunes on a creamy white background,

NEBULA recreates all the beauty of Skyline White, a highly distinctive marble with unusual long, blurred veins in an apparent state of perpetual movement.

SKYLINE WHITE

Un design qui rappelle les dunes désertiques dans des tons café sur un fond blanc crème.

NEBULA recrée le singulier marbre Skyline White, où se détache la singularité de ses veines allongées et estompées dans un mouvement perpétuel.



Rvto. / Wall / Rvtrm.: Nebula Almond 120x260
Pvto. / Floor / Sol: Rovere Bark 25x150



Rvto. / Wall / Rvrm.: Nebula Almond 120x260
Pvto. / Floor / Sol: Nebula Almond 120x120



Formatos / Sizes / Fomat

120x260 cm
47,24"x102,36"

6 mm



120x120 cm
47,24"x47,24"

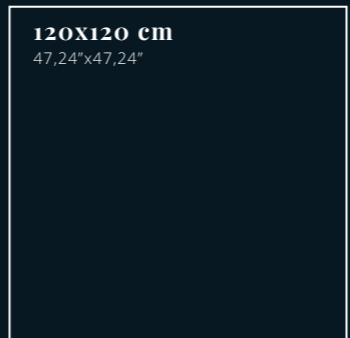

60x120 cm
23,62"x47,24"

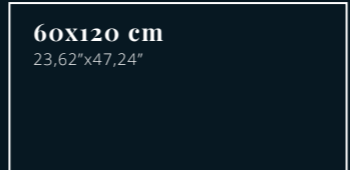

32,5x22,5 cm
12,79"x8,85"



30x30 (5x5) cm
11,81"x11,81"



NEBULA



CR. LUX
GRES PORCELÁNICO RECTIFICADO-GRANILLA PULIDA
RECTIFIED PORCELAIN TILES-POLISHED GRANILLA
GRÈS CÉRAMÉ RECTIFIÉE - GRANILLA POLI

LEVI GLASS
GRES PORCELÁNICO ESMALTADO PULIDO RECTIFICADO
POLISHED GLAZED RECTIFIED PORCELAIN TILES
GRÈS CÉRAMÉ ÉMAILLÉ POLI RECTIFIÉE



Empaquetado / Packaging / Emballage

Formato	pz/cj	m ² /cj	cj/pl	m ² /pl	kg/cj	kg/pl
60x120	2	1.44	32	46.08	34.50	1,129.00
120x120	1	1.44	36	51.84	38.40	1,422.40
32,5x22,5	9	-	-	-	13.50	-
30x30 (5)	11	1.00	42	42.00	23.00	986.00

Empaquetado / Packaging / Emballage

Formato	pz/pl	m ² /pz	m ² /pl	kg/pl
120x260	20	3.12	62.40	1,050.00

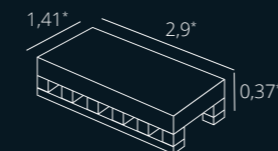

*Medidas en metros
*Dimensions in metres
*Dimensions en mètres

Nebula Almond

Formato	Rec.	M300	054.200.0097.09877	PEI 4
120x260	Rec.	M300	054.200.0097.09877	6mm
60x120	Rec.	M96	004.869.0097.09877	10,5mm
120x120	Rec.	M150	004.120.0097.09877	10,7mm

Malla Nebula

Almond	32,5x22,5	P46	038.297.0097.09877	10,5mm
Almond	30x30 (5)	M235	038.281.0097.09877	10,5mm

LUX NOOR

ESPÍRITU ROMPEDOR

La disposición caótica y potente de sus vetas rompen visualmente sobre la superficie de **LUX NOOR**. Un ónice que representa toda la magia de esta piedra natural.

GROUNDBREAKING SPIRIT

The chaotic and powerful layout of its seams burst visually onto **LUX NOOR's** surface. An onyx that represents all the magic of this natural stone.

UN ESPRIT RÉVOLUTIONNAIRE

La disposition chaotique et puissante de ses veines se brise visuellement sur la surface de **LUX NOOR**. Un onyx qui représente toute la magie de cette pierre naturelle.

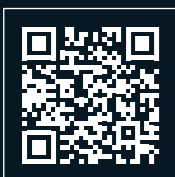

Rvto. / Wall / Rvtrm.: Lux Noor Berry 120x260
Pvto. / Floor / Sol: Lux Noor Berry 120x120 - Oldmanor Tabaco 25x150



Formatos / Sizes / Fomat

120x260 cm
47,24"x102,36"

6 mm

120x120 cm
47,24"x47,24"

60x120 cm
23,62"x47,24"

32,5x22,5 cm
12,79"x8,85"

30x30 (5x5) cm
11,81"x11,81"

LUX NOOR



CR. LUX
GRES PORCELÁNICO RECTIFICADO-GRANILLA PULIDA
RECTIFIED PORCELAIN TILES-POLISHED GRANILLA
GRÈS CÉRAME RECTIFIÉE - GRANILLA POLI

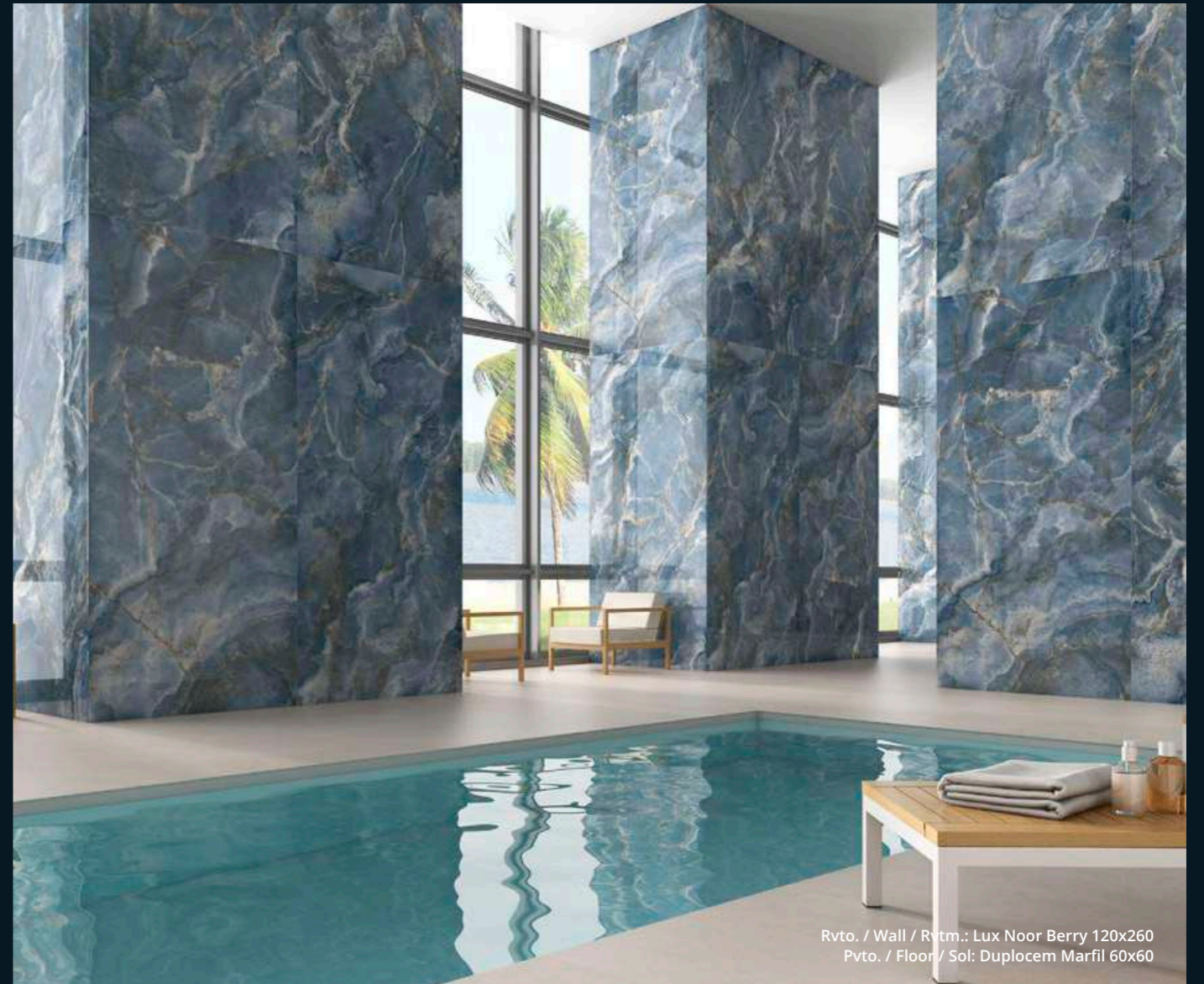

Rvto. / Wall / Rvrm.: Lux Noor Berry 120x260
Pvto. / Floor / Sol: Duplocem Marfil 60x60

Empaquetado / Packaging / Emballage

Formato	pz/cj	m²/cj	cj/pl	m²/pl	kg/cj	kg/pl
60x120	2	1.44	32	46.08	34.50	1,129.00
120x120	1	1.44	36	51.84	38.40	1,422.40
32,5x22,5	9	-	-	-	13.50	-
30x30 (5)	11	1.00	42	42.00	23.00	986.00

Empaquetado / Packaging / Emballage

Formato	pz/pl	m²/pz	m²/pl	kg/pl
120x260	20	3.12	62.40	1,050.00

Lux Noor Berry

Formato	Rec.	M300	054.200.0877.10660	PEI 4
● 120x260	Rec.	M300	054.200.0877.10660	6mm
● 60x120	Rec.	M132	046.869.0877.10660	10,5mm
● 120x120	Rec.	M185	046.120.0877.10660	10,7mm

Malla Lux Noor

Formato	P46	086.297.0877.10660	10,5mm
● Berry 32,5x22,5	P46	086.297.0877.10660	10,5mm
● Berry 30x30 (5)	M235	086.281.0877.10660	10,5mm

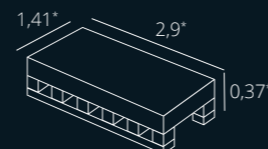

*Medidas en metros
*Dimensions in metres
*Dimensions en mètres

berry

PISA

ESENCIA DE 'CALACATTA'

La exclusiva gráfica de sus vetas fuertes y audaces encuentran la inspiración en el clásico e indemne mármol Macchia Vecchia. **PISA** presenta un cromatismo peculiar, con un blanco roto y unas finas vetas grises que se ven envueltas por el encanto de sus tonalidades ámbar y doradas.

THE ESSENCE OF 'CALACATTA' MARBLE

This series' exclusive strong-veined bold design is inspired by timeless classical Macchia Vecchia marble. **PISA** comes in a unique combination of colours, with an offwhite background covered in fine grey veins, charmingly streaked with amber and gold.

ESSENCE DE 'CALACATTA'

Le design exclusif de ses veinures fortes et audacieuses puise son inspiration dans le marbre Macchia Vecchia, classique et immuable. **PISA** présente un chromatisme particulier, avec un blanc cassé et de fines veinures grises mises en valeur par le charme de ses tonalités ambre et dorées..



Rvto. / Wall / Rvrm.: Pisa Gold 120x260 - Koncep Argent 120x260
Pvto. / Floor / Sol: Montpellier Graphite 120x120



Rvto. / Wall / Rvtrm.: Pisa Gold 120x260
Pvto. / Floor / Sol: Mosa Coal 90x90



gold

Formatos / Sizes / Fomat



Malla Twisted Gold 21x26
(Pisa Gold + Ardesia Noir)

PISA



Empaquetado / Packaging / Emballage

Formato	pz/cj	m ² /cj	cj/pl	m ² /pl	kg/cj	kg/pl
90x180	1	1,62	24	38,88	45,50	1,152,00
75x150	1	1,13	40	45,20	28,00	1,184,00
60x120	2	1,44	32	46,08	34,50	1,129,00
45x90	3	1,21	44	53,24	28,70	1,282,80
30x60	6	1,08	48	51,84	23,00	1,124,00
120x120	1	1,44	36	51,84	38,40	1,422,40
90x90	2	1,62	27	43,74	40,00	1,110,00
75x75	3	1,69	30	50,70	41,20	1,256,00
60x60	4	1,44	30	43,20	30,00	920,00
32,5x22,5	9	-	-	-	13,50	-
30x30(7)	11	1,00	42	42,00	23,10	990,20
21x26	8	-	-	-	9,60	-

Empaquetado / Packaging / Emballage

Formato	pz/pl	m ² /pz	m ² /pl	kg/pl
120x260	20	3,12	62,40	1,050,00

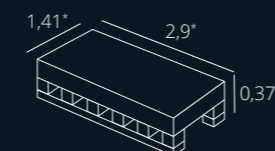

*Medidas en metros
*Dimensions in metres
*Dimensions en mètres

Pisa Gold

Formato	Rec.	M	Código	Clasificación	Grueso
120x260	Rec.	M300	054.200.0189.00145	PEI 4	6mm
90x180	Rec.	M168	004.505.0189.00145	LEV	11,5mm
75x150	Rec.	M114	004.350.0189.00145	LEV	10,5mm
60x120	Rec.	M83	017.869.0189.00145	MATT	10,5mm
60x120	Rec.	M96	004.869.0189.00145	LEV	10,5mm
45x90	Rec.	M65	004.805.0189.00145	LEV	11mm
30x60	Rec.	M48	017.450.0189.00145	MATT	9,5mm
30x60	Rec.	M61	004.450.0189.00145	LEV	9,5mm
120x120	Rec.	M150	004.120.0189.00145	LEV	10,7mm
90x90	Rec.	M74	017.804.0189.00145	MATT	10,5mm
90x90	Rec.	M88	004.804.0189.00145	LEV	10,5mm
75x75	Rec.	M74	004.875.0189.00145	LEV	10,5mm
60x60	Rec.	M48	017.840.0189.00145	MATT	9,5mm
60x60	Rec.	M61	004.840.0189.00145	LEV	9,5mm
9x30	Rec.	M136	038.137.0189.00145	LEV	9,5mm
9x30	Rec.	M118	041.137.0189.00145	MATT	9,5mm

Malla Pisa

Gold	30x30 (7)	M185	025.590.0189.00145	MATT	9,5mm
Gold	30x30 (7)	M185	038.590.0189.00145	LEV	9,5mm
Gold	32,5x22,5	P46	025.297.0189.00145	MATT	9,5mm
Gold	32,5x22,5	P46	038.297.0189.00145	LEV	9,5mm

Malla Twisted

Gold	21x26	P20	038.237.0189.01643	LEV	9,5mm
------	-------	-----	--------------------	-----	-------

CR. LUX

GRES PORCELÁNICO RECTIFICADO-GRANILLA PULIDA
RECTIFIED PORCELAIN TILES-POLISHED GRANILLA
GRÈS CÉRAMÉ RECTIFIÉE - GRANILLA POLI

LEVIGLASS

GRES PORCELÁNICO ESMALTADO PULIDO RECTIFICADO
POLISHED GLAZED RECTIFIED PORCELAIN TILES
GRÈS CÉRAMÉ ÉMAILLÉ POLI RECTIFIÉE

COMPACGLASS

GRES PORCELÁNICO ESMALTADO RECTIFICADO
RECTIFIED GLAZED PORCELAIN TILES
GRÈS CÉRAMÉ ÉMAILLÉ RECTIFIÉE

PLAIN



DECORSTONE
GRES PORCELÁNICO RECTIFICADO
RECTIFIED PORCELAIN TILES
GRÉS CÉRAME RECTIFIÉE

Formatos / Sizes / Fomat

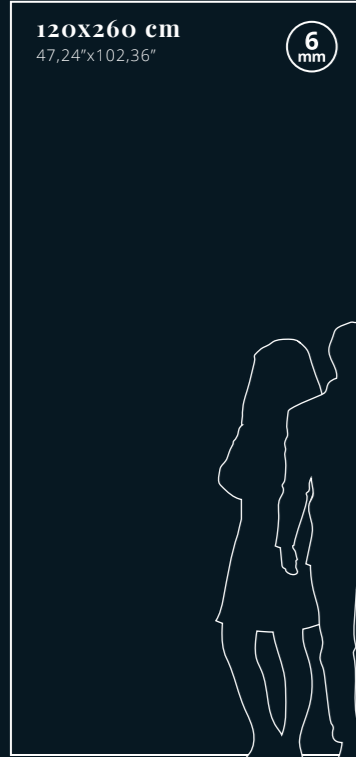

Plain Black
● 120x260 Rec. M204 052.200.0157.09879 6mm

Plain White
● 120x260 Rec. M204 052.200.0108.09879 6mm

Empaquetado / Packaging / Emballage

Formato	pz/pl	m ² /pz	m ² /pl	kg/pl
120x260	20	3.12	62.40	1,050.00

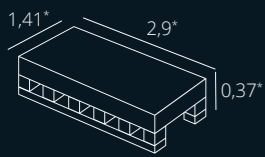

*Medidas en metros
*Dimensions in metres
*Dimensions en mètres

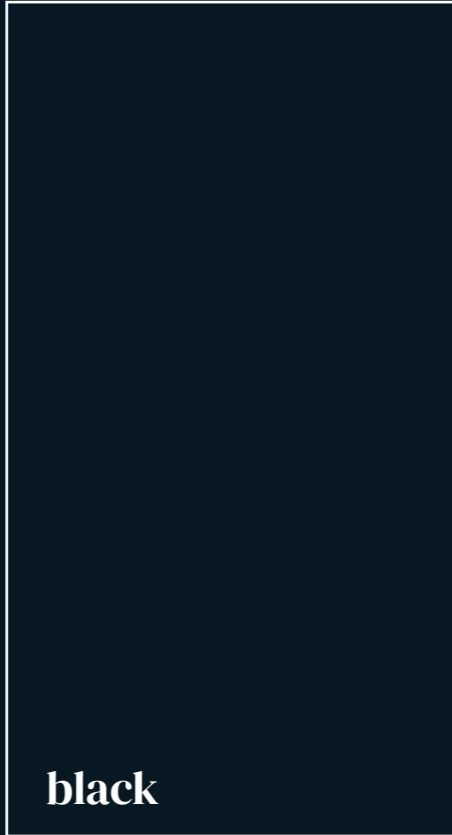

black



white



Rvto. / Wall / Rvttm.: Plain Black 120x260 - Plain White 120x260
Pvto. / Floor / Sol: Mosa Gris 90x90

TORANO

INFUSIÓN ACARAMELADA

La gran variedad estética del eterno Paonazzo está reflejada en **TORANO**. Un diseño altamente diferencial y de gran belleza, caracterizado por su alto valor decorativo. Este mármol, muestra en sus finas vetas, una infusión acaramelada, pero con matices oscuros. En su esencia se aprecia el efecto del mármol oxidado a causa del paso del tiempo.

CARAMEL WITH DARKER HINTS OF COLOUR

TORANO reflects the visual diversity of Paonazzo marble. With its timeless beauty and singular design, strong decorative appeal is guaranteed. The slender veins of this marble combine shades of caramel with darker hints of colour, in addition to signs of oxidation slowly built up over time.

TON CARAMEL, MAIS AVEC DES NUANCES SOMBRES

La grande variété esthétique de l'éternel Paonazzo se reflète dans **TORANO**. Un design hautement différentiel et d'une grande beauté, caractérisé par sa haute valeur décorative. Ce marbre présente dans ses veines fines un ton caramel, mais avec des nuances sombres. En son essence on observe l'effet du marbre oxydé par le passage du temps

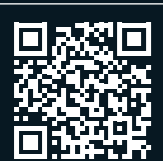





Formatos / Sizes / Fomat

120X260 cm
47,24"x102,36"

6 mm



120X120 cm
47,24"x47,24"

60X60 cm
23,62"x23,62"

60X120 cm
23,62"x47,24"

30X60 cm
11,81"x23,62"

75X150 cm
29,52"x59,05"

19,8X22,8 cm
7,79"x8,97"

30X30 (5X5) cm
11,81"x11,81"

32,5X22,5 cm
12,79"x8,85"

TORANO



CR. LUX
GRES PORCELÁNICO RECTIFICADO-GRANILLA PULIDA
RECTIFIED PORCELAIN TILES-POLISHED GRANILLA
GRÈS CÉRAMÉ RECTIFIÉE - GRANILLA POLI

LEVIGLASS
GRES PORCELÁNICO ESMALTADO PULIDO RECTIFICADO
POLISHED GLAZED RECTIFIED PORCELAIN TILES
GRÈS CÉRAMÉ ÉMAILLÉ POLI RECTIFIÉE

COMPACGLASS
GRES PORCELÁNICO ESMALTADO RECTIFICADO
RECTIFIED GLAZED PORCELAIN TILES
GRÈS CÉRAMÉ ÉMAILLÉ RECTIFIÉE



Empaquetado / Packaging / Emballage

Formato	pz/cj	m²/cj	cj/pl	m²/pl	kg/cj	kg/pl
75x150	1	1.13	40	45.20	28.00	1,184.00
60x120	2	1.44	32	46.08	34.50	1,129.00
120x120	1	1.44	36	51.84	38.40	1,422.40
60x60	4	1.44	30	43.20	30.00	920.00
30x60	6	1.08	48	51.84	23.00	1,124.00
19,8x22,8	24	0.84	48	40.32	18	884.00
32,5x22,5	9	-	-	-	13.50	-
30x30 (5)	11	1.00	42	42.00	23.00	986.00

Empaquetado / Packaging / Emballage

Formato	pz/pl	m²/pz	m²/pl	kg/pl
120x260	20	3.12	62.40	1,050.00

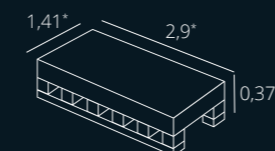

*Medidas en metros
*Dimensions in metres
*Dimensions en mètres

Torano Dorado

Formato	Rec.	M	Ref.	Icon	PEI
120x260	Rec.	M300	054.200.0103.09878	LEV	6mm
120x120	Rec.	M204	052.200.0103.09878	MATT	6mm
75x150	Rec.	M114	004.350.0103.09878	LEV	10,5mm
60x120	Rec.	M96	004.869.0103.09878	LEV	10,5mm
30x60	Rec.	M61	004.450.0103.9878	LEV	9,5mm
120x120	Rec.	M150	004.120.0103.09878	LEV	10,7mm
60x60	Rec.	M61	004.840.0103.09878	LEV	9,5mm

Malla Torano

Dorado	32,5x22,5	P46	038.297.0103.09878	LEV	9,5mm
Dorado	30x30 (5)	M235	038.281.0103.09878	LEV	9,5mm

Torano M. Dorado

Formato	Rec.	M	Ref.	Icon	PEI
60x120	Rec.	M83	017.869.0103.10106	MATT	10,5mm
120x120	Rec.	M123	017.120.0103.10106	MATT	10,7mm
30x60	Rec.	M48	017.450.0103.10106	MATT	9,5mm
60x60	Rec.	M48	017.840.0103.10106	MATT	9,5mm
19,8x22,8	Rec.	M74	015.292.0103.10106	MATT	10mm

Malla Torano M.

Dorado	30x30 (5)	M235	025.281.0103.10106	MATT	9,5mm
Dorado	32,5x22,5	P46	025.297.0103.10106	MATT	9,5mm

Get inspired...

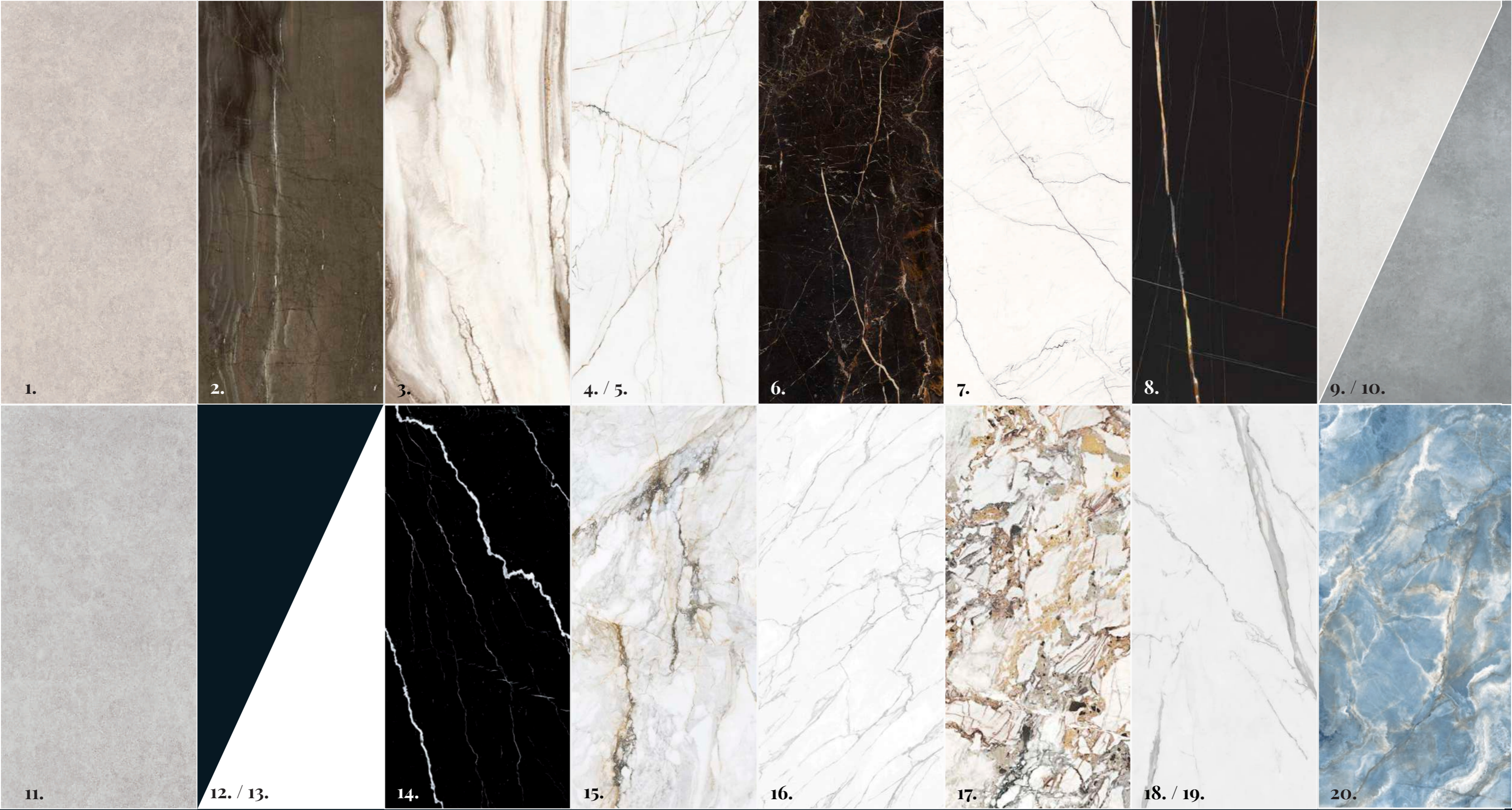

1. Moleanos Sand / 2. Lux Jatobá Brown / 3. Nebula Almond / 4. Torano Dorado Pulido / 5. Torano Dorado Satén
 11. Moleanos Pearl / 12. Plain Black / 13. Plain White / 14. Lux Deva Nero / 15. Pisa Gold / 16. Lincoln White Pulido

6. Lux Laurants Brown / 7. Desert Natural / 8. Lux Jebel Noir / 9. Konzept Nacar / 10. Konzept Argent
 17. Lux Grotta Oro / 18. Cellini Blanco Pulido / 19. Cellini Blanco Satén / 20. Lux Noor Berry

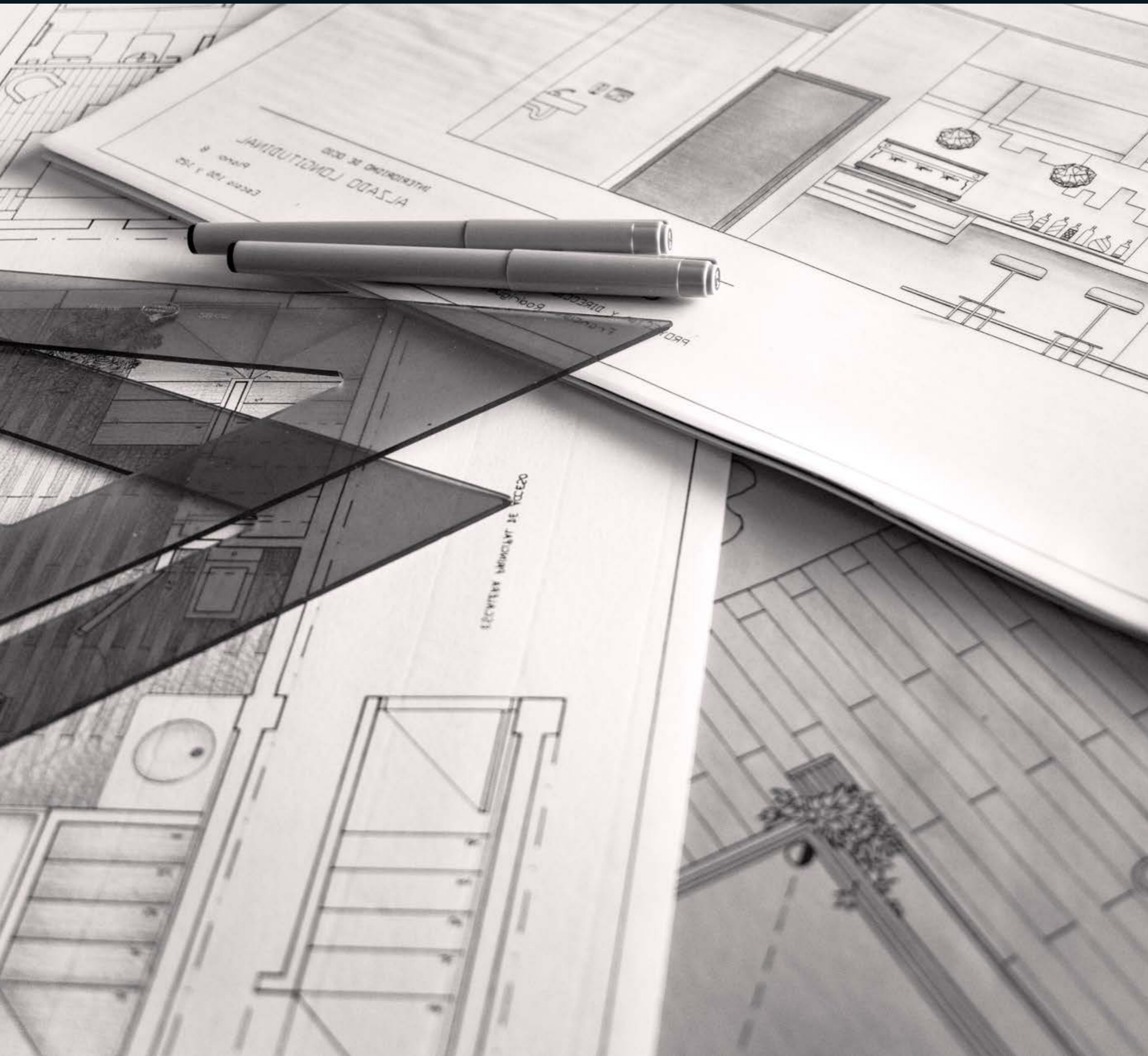

Expositores y recomendaciones

Display units & recommendations

Présentoirs et recommandations

EXPOSITOR PARA FORMATO 120x260

DISPLAY UNIT FOR 120x260 FORMAT / PRÉSENTOIR POUR FORMAT 120X260





ESTRUCTURA BASE
BASE STRUCTURE / TRANSPORT

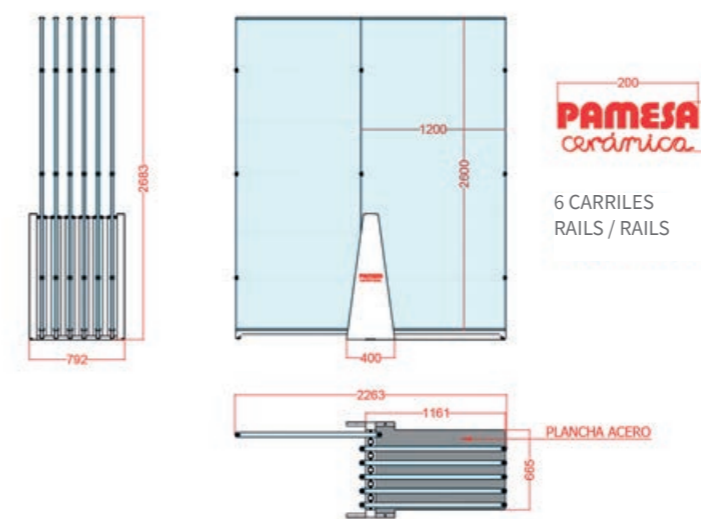

MARCO HIERRO Y GRAPAS
IRON FRAME & CLIPS / TRANSPORT





EMBALAJE EXPOSITOR
DISPLAY PACKAGING
EMBALLAGE DE PRÉSENTOIR

 2900x1410x550(h)mm
 350 Kg

12 MUESTRAS / SAMPLES / ÉCHANTILLONS
PLACA / SLAB / PIÈCE 2600x1200x6 mm

1. LUX LAURANTS BROWN
2. CELLINI BLANCO (PULIDO)
3. NEBULA ALMOND
4. DESERT NATURAL
5. PISA GOLD
6. LUX JATOBÁ BROWN
7. LINCOLN WHITE
8. TORANO DORADO (PULIDO)
9. CELLINI BLANCO (MATE)
10. MOLEANOS SAND
11. MOLEANOS PEARL
12. LUX DEVA NERO

EMBALAJE 12 PLACAS
12 SLABS PACKAGING
EMBALLAGE 12 PIÈCES

 2900x1410x370(h)mm
 573 Kg



DETALLE GRAPAS
CLOSE-UP OF CLIPS / TRANSPORT



Dimensiones y acabados pueden sufrir pequeñas variaciones por cuestiones técnicas.
Due to technical reasons, dimensions and finishes may vary slightly.
Pour des raisons techniques, les dimensions et finitions peuvent varier très légèrement.

CAJA XXL
XXL BOX / BOÎTE XXL



20 MUESTRAS / SAMPLES / ÉCHANTILLONS
PLACA / SLAB / PIÈCE 175x270x6 mm

1. Cellini Blanco Pulido
2. Cellini Blanco Satén
3. Desert Natural
4. Konzept Argent
5. Konzept Nacar
6. Lincoln White Pulido
7. Lux Deva Nero
8. Lux Grotta Oro
9. Lux Jatobá Brown
10. Lux Jebel Noir
11. Lux Laurants Brown
12. Lux Noor Berry
13. Moleanos Pearl
14. Moleanos Sand
15. Nebula Almond
16. Pisa Gold Pulido
17. Plain Black
18. Plain White
19. Torano Dorado Pulido
20. Torano Dorado Satén

TRANSPORTE

MOVING SLABS / TRANSPORT

El transporte de piezas de gran formato exige varios operarios.

Será necesario el uso de ventosas y se podrán usar en todas sus variantes (1).

Para piezas con superficie texturizada se recomienda el uso de ventosas que dispongan de una goma blanda, que garantiza la adherencia de las mismas (2).

Para facilitar el manejo y evitar la deformación, se pueden usar barras de transporte (3).

La solución óptima, consiste en el uso de un bastidor rígido, dotado de ventosas, que sujete las piezas en todas direcciones sin deformaciones, posibilitando el transporte con solo dos operarios.

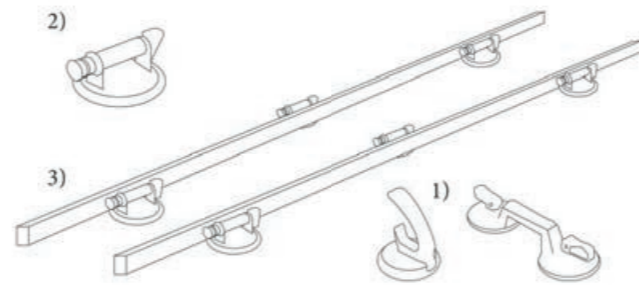

Several workmen will be needed to carry large-format slabs.

Suctions cups will be necessary. Different types can be used (1).

In the case of slabs with a textured surface, soft-rubber suction cups should be used to guarantee a good grip (2).

To handle the slabs more easily and prevent the risk of warpage, carrying bars should be used (3).

The best solution is a rigid frame, with suction cups that grip the slab along all sides. This prevents warpage and allows just two workmen to carry it.

Le transport des pièces de grand format requiert plusieurs opérateurs.

Il sera nécessaire d'employer des ventouses et on pourra les utiliser dans toutes leurs variantes (1).

Pour les pièces avec une surface texturisée, il est recommandé l'utilisation de ventouses qui ont un caoutchouc mou pouvant garantir leur adhérence (2).

Pour faciliter le maniement et éviter les déformations, on peut utiliser des barretransport (3).

La meilleure solution est d'utiliser un support rigide muni de ventouses pour fixer les pièces dans toutes les directions sans déformations, ce qui permet que deux opérateurs suffisent pour réaliser le transport.

RECOMENDACIONES DE ALMACENAMIENTO

STORAGE RECOMMENDATIONS / RECOMMANDATIONS DE STOCKAGE

Para una correcta manipulación de los cajones, se usará una carretilla elevadora con palas de 2,5 metros de longitud extendidas al máximo.

En condiciones normales, situar las palas en la mitad de la parte más larga del pallet para sujetar la máxima profundidad.

Nunca utilizar el hueco central para cargar.

To handle the crates properly, a fork-lift truck with 2.5-metre-long forks, when fully extended, should be used.

Under normal conditions, the forks should be slid under the middle of the longest side of the pallet so that they support most of the underside.

Never use the central opening in the crates to load them.

Pour une manipulation adéquate des caisses, on utilisera un chariot élévateur de 2,5 m de longueur à son extension maximale.

Dans des conditions normales, les fourches se placent au centre de la partie longue de la palette pour les introduire au plus profond de la palette.

Ne jamais introduire de fourche dans le creux central pour charger.

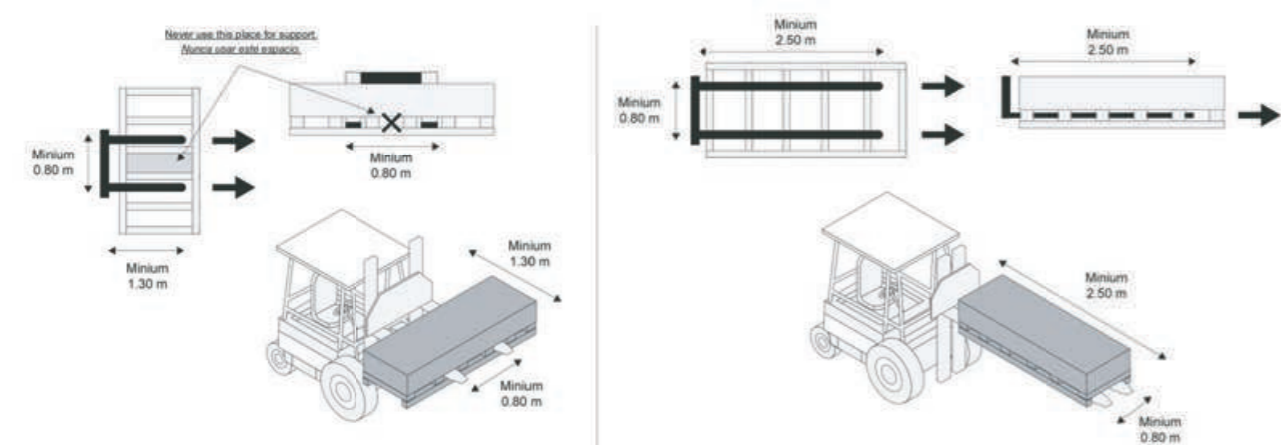

RECOMENDACIONES DE CORTE, PERFORACIÓN Y ACABADO

CUTTING, DRILLING AND FINISHING RECOMMENDATIONS / RECOMMANDATIONS DE COUPE, PERÇAGE ET FINITION

Las grandes dimensiones de las piezas no impiden operaciones de corte, perforación y acabados de cantos y se pueden realizar en la misma obra con el equipamiento adecuado.

CORTE CON GUÍAS DE CORTE EN SECO

01. Primero se coloca la pieza cerámica en la mesa de trabajo.

02. Se marca la línea de corte, situamos la guía y la fijamos en su posición.

03. A continuación, se raya con el rodel la pieza, marcando los dos primeros centímetros hacia atrás y continuando con el resto de la placa, marcando con fuerza constante hasta el extremo contrario.

04. Para proceder con la separación, se presiona con la tenaza hasta escuchar el sonido de la rotura.

05. Finalmente se separan las piezas restantes con ayuda del borde de la mesa y ejerciendo la fuerza necesaria.

Despite the large dimensions of the tiles, they can be cut, drilled and their edges finished. This can be done on the worksite with appropriate equipment.

DRY-CUTTING USING A GUIDE RAIL

01. First, place the ceramic slab on top of the workbench.

02. Mark the cutting line, and then fix the guide rail into place.

03. Score the beginning of the slab with the cutting wheel, starting two centimetres from the edge and pulling back to the beginning of the slab. Then continue across to the other side, applying constant pressure.

04. To separate the two parts, exert pressure with a pair of pliers until a breaking sound is heard.

05. Use the edge of the workbench to snap the two pieces apart, exerting the necessary pressure.

Les grandes dimensions des pièces n'empêchent pas les opérations de coupe et de perçage et les finitions des chants, et on peut les réaliser sur le propre chantier avec l'équipement adéquat.

DÉCOUPE AVEC GUIDES DE COUPE À SEC

01. Placer d'abord la pièce en céramique sur la table de travail.

02. Marquer la ligne de coupe, situer le guide et le fixer dans sa position.

03. Ensuite, rayer la pièce à l'aide de la molette, en marquant les deux premiers centimètres vers l'arrière puis en continuant sur le reste de la pièce, en marquant avec une force constante jusqu'à l'extrémité opposée.

04. Pour procéder à la séparation, faire pression avec la pince jusqu'à entendre un bruit de cassure.

05. Finalement, séparer les pièces restantes en s'aidant du bord de la table et en exerçant la force nécessaire.

CORTE CON GUÍAS Y RADIAL

También podemos hacer uso de una guía y una radial con agua.

CUTTING WITH A GUIDE RAIL AND RADIAL TILE SAW

También podemos hacer uso de una guía y una radial con agua.

DÉCOUPE AVEC GUIDES ET DISQUEUSE

On peut également utiliser un guide et une disqueuse à eau.

TALADROS Y AGUJEROS

Para realizar agujeros se deben usar taladros no percutores. Se recomienda empezar con bajas revoluciones y refrigerar con agua.

DRILLING AND MAKING HOLES

To make holes, do not use drills in the hammer mode. Start at a low speed and refrigerate the bit with water.

PERCEUSES ET TROUS

Pour percer des trous on doit utiliser des perceuses sans percussion. Il est recommandé de commencer avec de faibles révolutions et refroidir à l'eau.



VÍDEO DE COLOCACIÓN.
LAYING VIDEO.
VIDÉO DE POSE.



VÍDEO DE CORTE.
CUTTING VIDEO.
VIDÉO DE COUPE.

PAMESA CERÁMICA aplica una política de continuo desarrollo de sus productos y se reserva el derecho a realizar cambios en los productos, colores, especificaciones técnicas, packings y códigos sin previo aviso.

PAMESA ha realizado un esfuerzo considerable para que toda la información sea adecuada en el momento de la publicación del catálogo.

A causa de las limitaciones del proceso de impresión los colores reproducidos pueden sufrir ligeras variaciones con respecto al producto original.

PAMESA informa que este catálogo tiene validez a nivel informativo y por tanto no se hace responsable de los posibles errores de impresión; reservándose el derecho de realizar modificaciones sin necesidad de preaviso.

PAMESA CERÁMICA operates a policy of continuous development and reserves the right to make changes to its products, colours, engineering specifications, packaging and codes without prior notice.

PAMESA has taken every effort to ensure that the information contained in the catalogue is correct at the time of publication. Due to the limitations of the printing process, the colours reproduced may vary slightly from the original product.

PAMESA advises that this catalogue is only valid for information purposes and therefore does not accept responsibility for any possible printing errors.

PAMESA CERÁMICA applique une politique de développement continu de ses produits et se réserve le droit de réaliser des changements, que ce soit de produits, couleurs, spécifications techniques, paquetages et codifications et cela sans en aviser préalablement l'acheteur.

PAMESA a réalisé un effort considérable pour que toute l'information donnée soit adéquate au moment de la publication du catalogue. Dues aux limitations du processus d'impression, les couleurs reproduites peuvent souffrir de légères variations avec le produit original.

PAMESA vous informe que les informations de ce catalogue sont données à titre informatif et qu'elle n'est pas responsable des possibles erreurs d'impression. De plus, elle se réserve le droit de modifier les informations sans préavis.

PAMESA
cerámica

CALLE PINA DE MONTALGRAO 2
(CARRETERA VILLARREAL-ONDA KM 2,7)
12540 VILA-REAL, CASTELLÓN (SPAIN)

TEL: +34 964 50 75 00

www.pamesa.com



PAMESA
cerámica